



GENERATOR TYPE ECO 40-2S/4

Document : **DS023A/1**

issue 011 date 12/01/2015

Electrical Characteristics										
Frequency	Hz	50				60				
Voltage (parallel star)	V	380	400	415	440	415	440	460	480	
Rated power class H	kVA	450	450	450	360	480	510	540	540	
	kW	360	360	360	288	384	408	432	432	
Rated power class F	kVA	410	410	410	330	435	460	490	490	
	kW	328	328	328	264	348	368	392	392	
Regulation with	DER1	±1% with any power factor and speed variations between -5% +30%								
Insulation class		H								
Execution		Brushless								
Stator winding		12 ends								
Rotor		with damping cage								
Efficiencies class H	4/4	%	94,1	94,4	94,2	93,9	94,5	95	95,2	95,3
(see graph. for details)	3/4	%	94,3	94,6	94,5	94,1	94,6	95,1	95,3	95,5
	2/4	%	93,5	93,8	93,7	93,5	93,5	94	94,2	94,4
	1/4	%	89,4	89,5	89,4	89,2	90,6	90,9	91,1	91,2
Reactances (f. l.cl. F)	Xd	%	312	232	215	155	434	384	312	232
	Xd'	%	22,7	21,4	19,5	14,4	24,6	23,4	22,7	21,4
	Xd''	%	12,9	12,1	11	8,1	14,1	13,2	12,9	12,1
	Xq	%	122	107	101	71,7	147	132	122	107
	Xq'	%	122	107	101	71,7	147	132	122	107
	Xq''	%	29,1	27,4	25,2	18,4	31,7	30,2	29,1	27,4
	X ₂	%	18,2	17,6	16,4	11,8	20,2	19,4	18,2	17,6
	X ₀	%	3,6	3,1	2,9	2,1	4,1	3,9	3,6	3,1
Short Circuit Ratio	Kcc		0,32	0,43	0,46	0,64	0,23	0,26	0,32	0,43
Time Constants	Td'	sec.	0,13							
	Td''	sec.	0,019							
	Tdo'	sec.	2,70							
	Tα	sec.	0,03							
Short Circuit Current Capacity		%	>300				>350			
Excitation at no load	Amp.		0,4	0,6	0,8	1,6	0,3	0,4	0,5	0,6
Excitation at full load	Amp.		3,3	3,4	3,7	4,5	2,8	2,9	3	3,2
Overload (long-term)	%	1 hour in a 6 hours period 110% rated load								
Overload per 20 sec.	%	300								
Stator Winding Resistance (20°C)	Ω	0,013								
Rotor Winding Resistance (20°C)	Ω	4,881								
Exciter Resistance (20 °C)	Ω	Rotor : 0,317				Stator : 8,85				
Heat dissipation at f.l.cl.H	W	22572	21356	22166	18709	22349	21474	21782	21305	
Telephone Interference		THF < 2%				TIF < 40				
Radio interference		EN61000-6-3, EN61000-6-2. For others standards apply to factory								
Waveform Distors.(THD) at f. load	LL/LN %	2,5 / 2,6								
Waveform Distors.(THD) at no load	LL/LN %	2,7 / 2,8								
Mechanical characteristics										
Protection		IP 21 (other protection on request)								
DE bearing		6322								
NDE bearing		6318.2RS								
Weight of wound stator assembly	kg	382								
Weight of wound rotor assembly	kg	245,8								
Weight of complete generator	kg	1118								
Maximun overspeed	rpm	2250								
Unbalanced magnetic pull at f.l.cl.F	kN/mm	5,9								
Cooling air requirement	m³/min	54				64,8				
Inertia Constant (H)	sec.	0,177				0,213				
Noise level at 1m/7m	dB(A)	94 / 82				98 / 88				

All technical data are to be considered as a reference and they can be modified without any notice.

This document is a propriety of Mecc Alte S.p.A.. All rights reserved.



GENERATOR TYPE ECO 40-2S/4

Document : **DS023A/2**
 issue 011 date : 12/01/2015

50 Hz

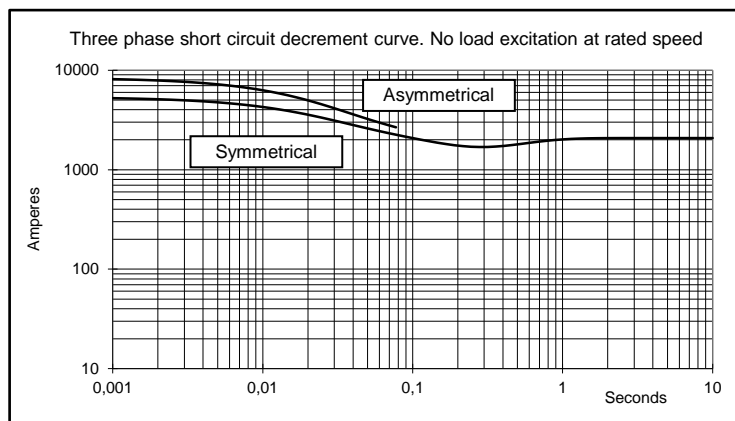
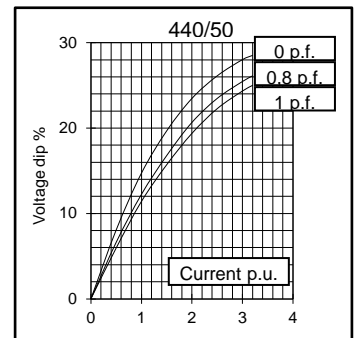
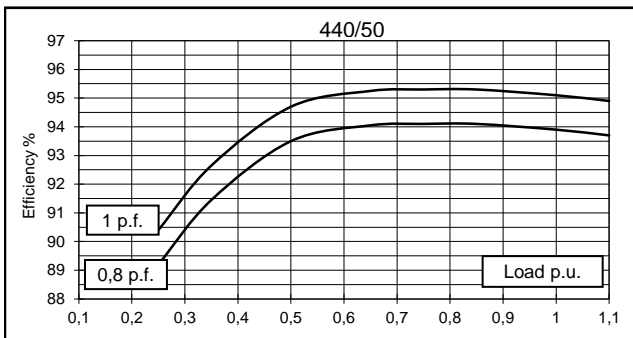
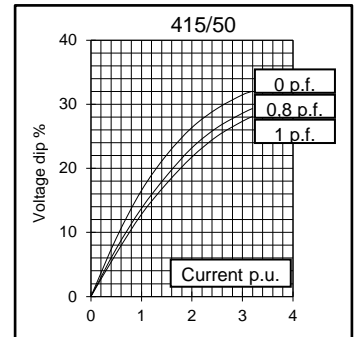
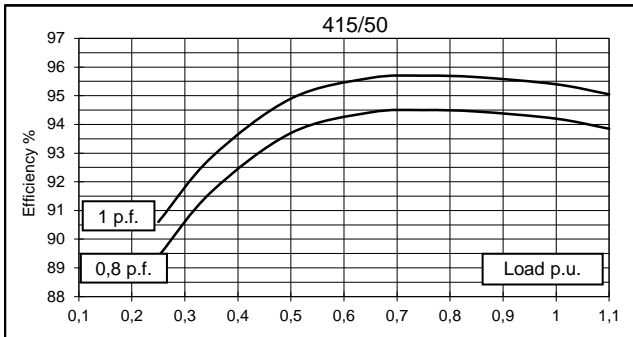
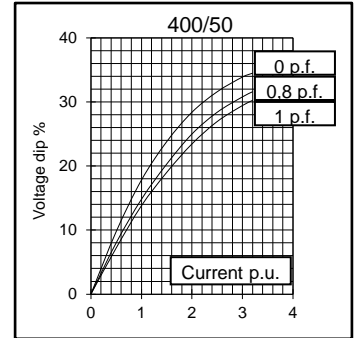
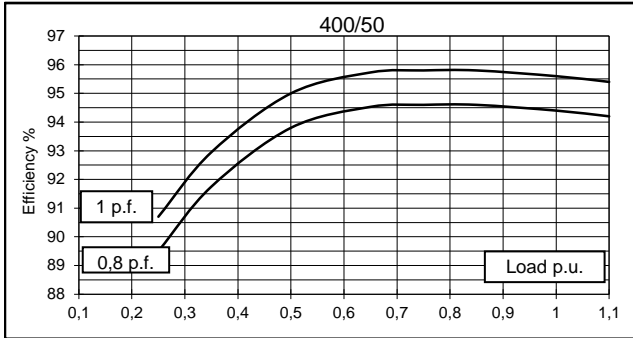
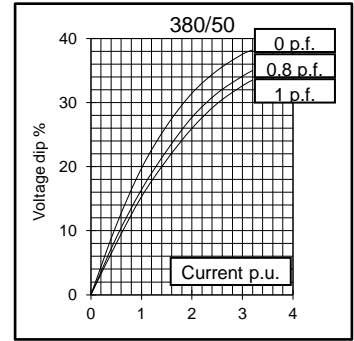
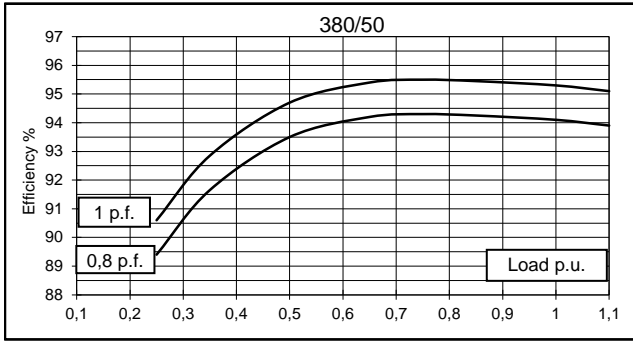



60 Hz

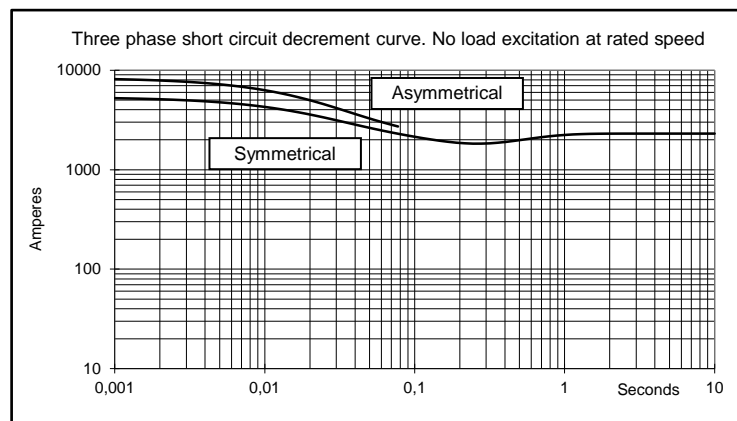
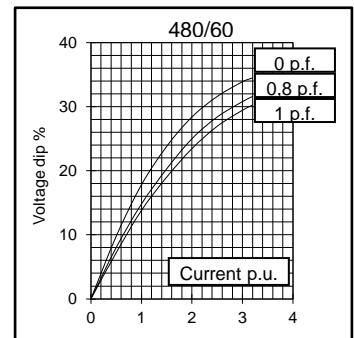
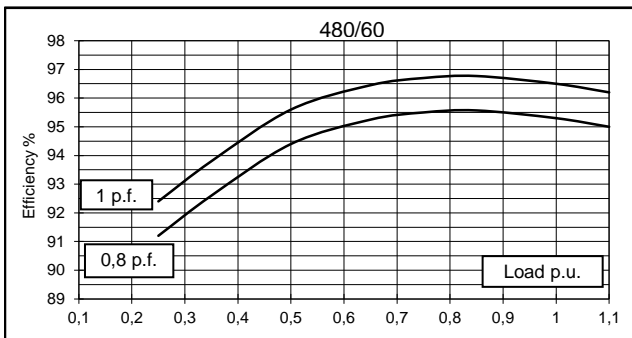
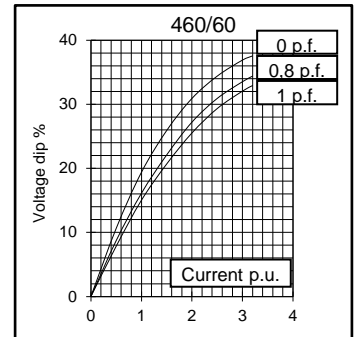
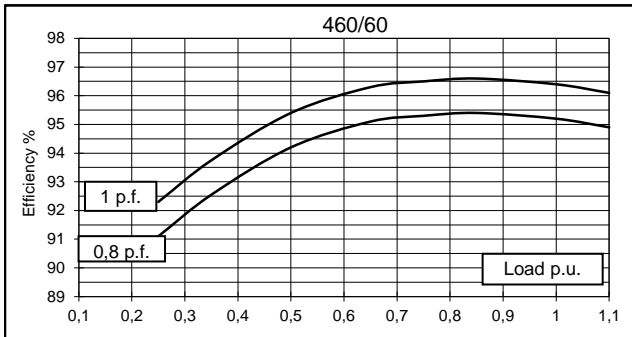
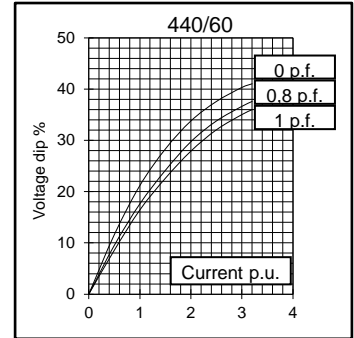
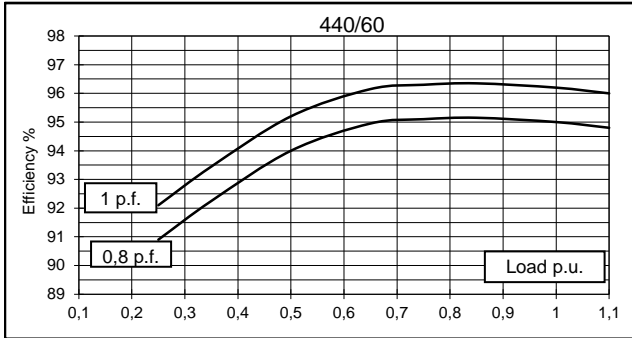
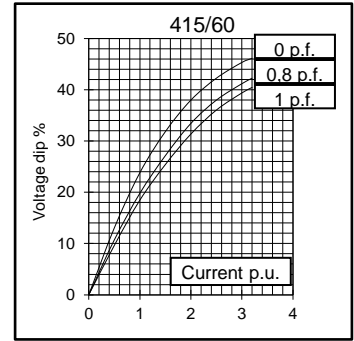
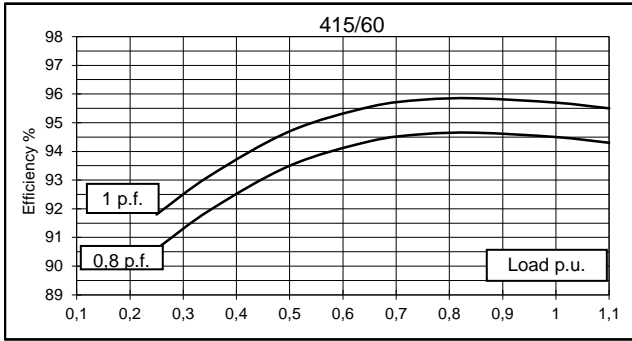

TWO BEARING MOMENTS OF INERTIA

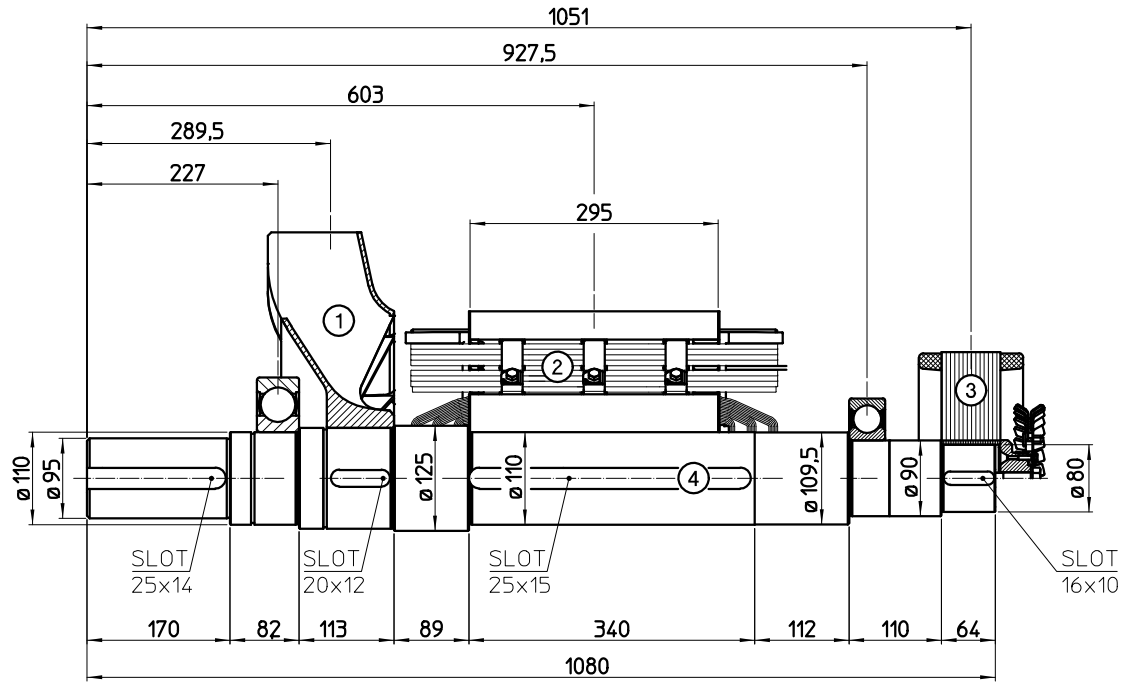

COMPONENT	WEIGHT kg	J kgm ²
1 FAN	10,2	0,335
2 MAIN ROTOR	245,8	5,234
3 EX. ROTOR	35	0,562
4 SHAFT	73,6	0,109
TOTAL	364,6	6,24

TWO BEARING DIMENSIONS

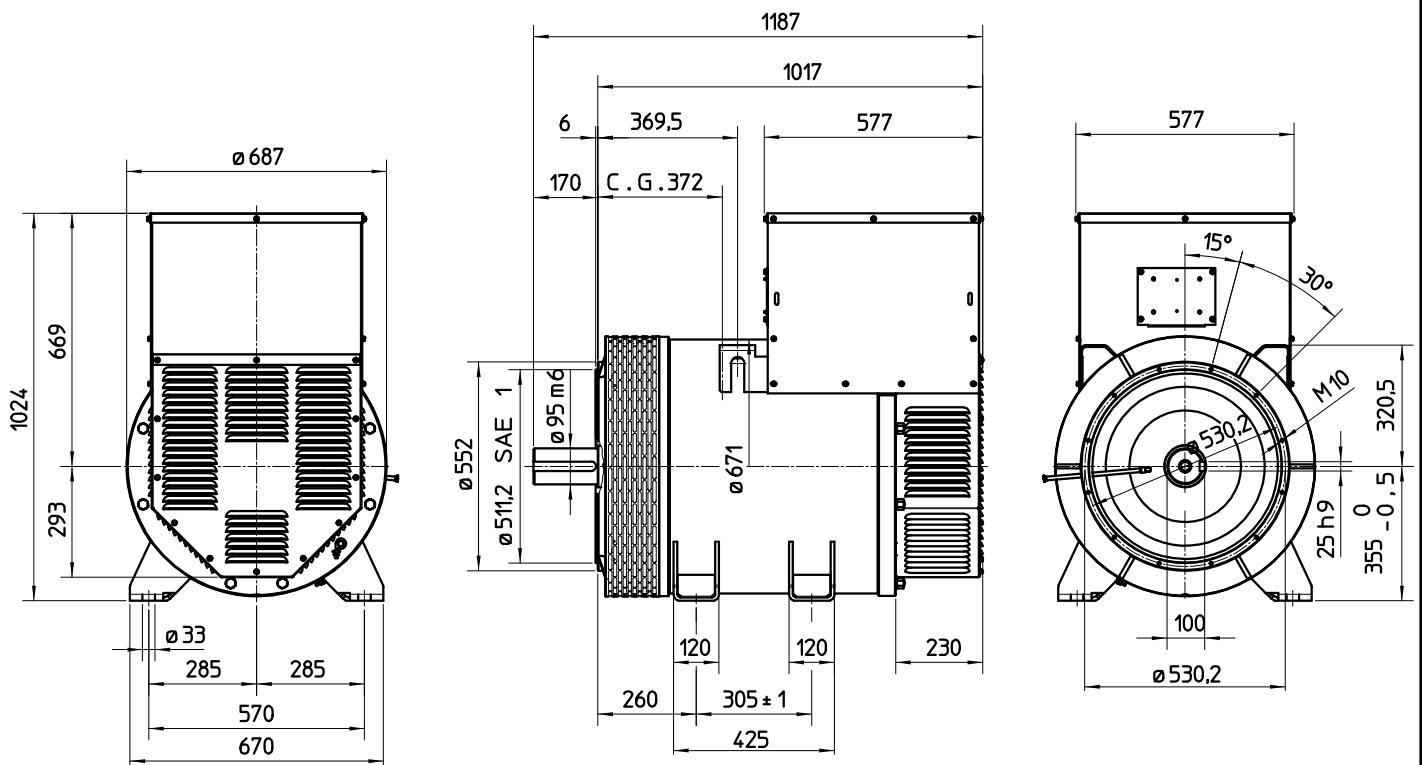

C.G.= GRAVITY CENTER

SINGLE BEARING MOMENTS OF INERTIA

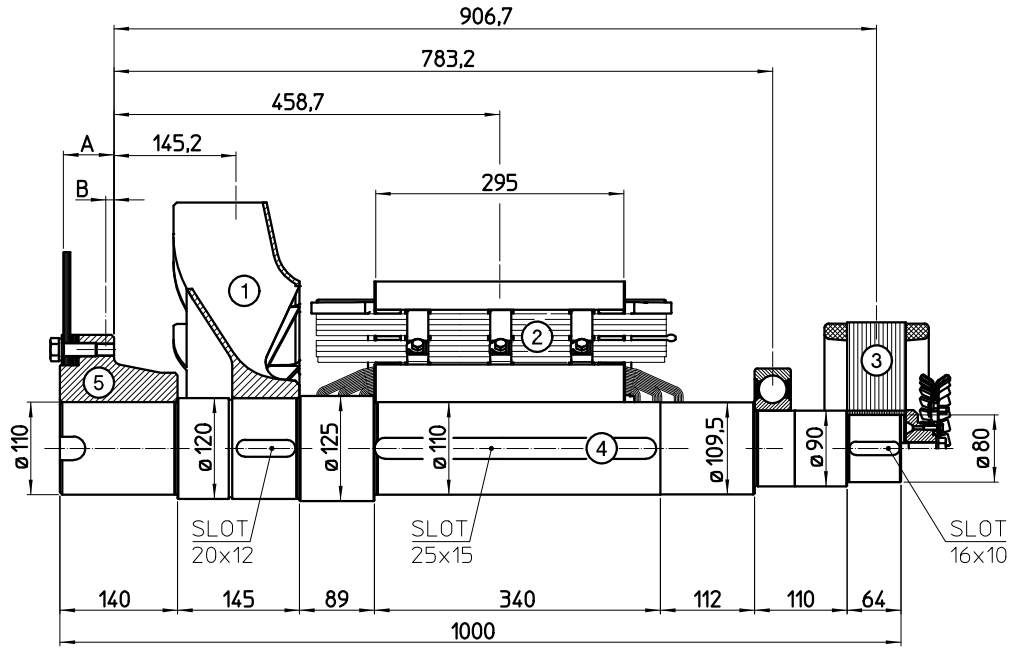

COMPONENT	WEIGHT kg	J kgm ²
1 FAN	10,2	0,335
2 MAIN ROTOR	245,8	5,234
3 EX. ROTOR	35	0,562
4 SHAFT	72	0,111
TOTAL	363	6,242

Sae No	SHAFTS COUPLING FLEX PLATE			
	A	B	WEIGHT kg	J kgm ²
14	60	9,6	41,4	0,511
18	50	6,6	45,1	0,858

SINGLE BEARING DIMENSIONS

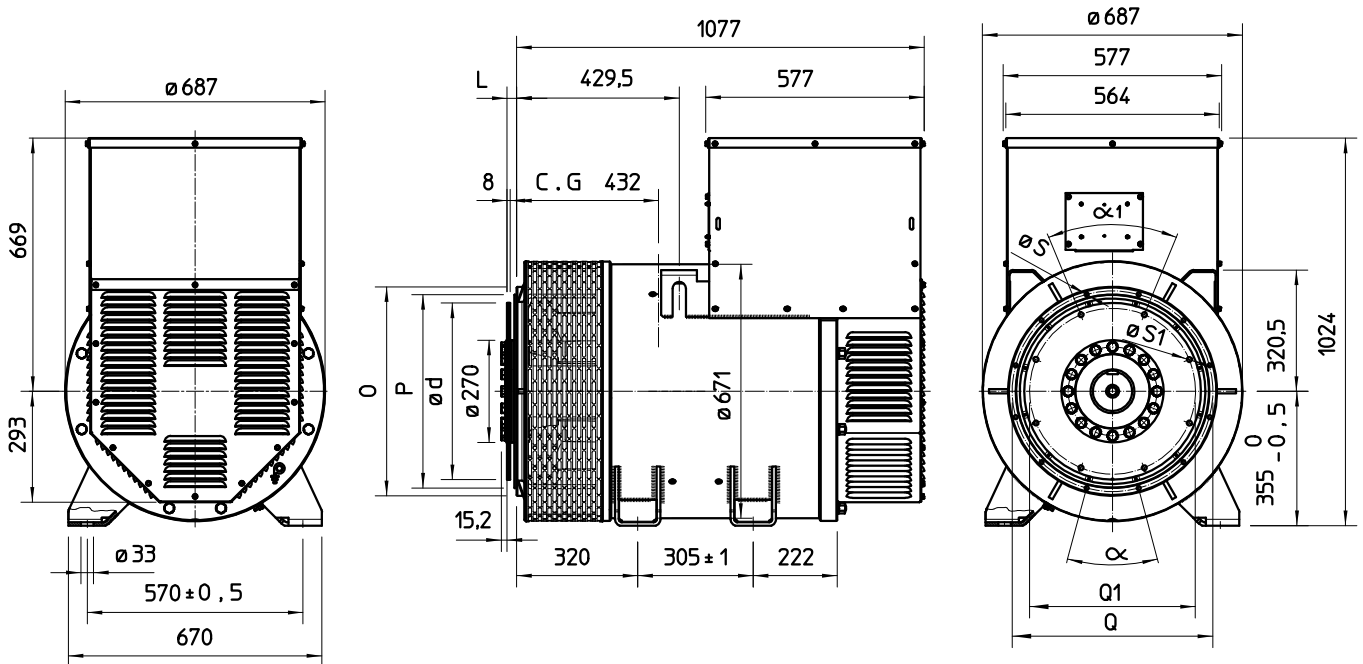

SAE N.	FLANGIA / FLANGE BRIDE / FLANSCH					
	O	P	Q	N. FORI	S	α
1	552	511,2	530,2	12	11	30°
1/2	648	584,2	619,1	12	14	30°
0	711	647,7	679,5	16	14	22,5°
00	883	787,4	850,9	16	14	22,5°

VOL. N.	GIUNTI A DISCHI / DISC COUPLING DISQUE DE MONOPALIER / SCHEIBENKUPPLUNG					
	L	d	Q1	N. FORI	S1	α1
14	25,4	466,72	438,15	8	14	45°
18	15,7	571,5	542,92	6	17	60°

C.G.= GRAVITY CENTER