



**GENERATOR TYPE ECO 46-2L/4**

Document : **DS063A/1**

issue 004 date 01/04/2014

<b>Electrical Characteristics</b>										
Frequency	Hz	50				60				
Voltage (parallel star)	V	380	400	415	440	415	440	460	480	
Rated power class H	kVA	2500	2500	2500	2280	2700	2840	3000	3000	
	kW	2000	2000	2000	1824	2160	2272	2400	2400	
Rated power class F	kVA	2250	2250	2250	2050	2430	2550	2700	2700	
	kW	1800	1800	1800	1640	1944	2040	2160	2160	
Regulation with DER1		±1% with any power factor and speed variations between -5% +30%								
Insulation class		H								
Execution		Brushless								
Stator winding		12 ends								
Rotor		with damping cage								
Efficiencies class H	4/4	%	96,9	96,8	96,6	96,4	96,8	97	97,2	97,1
(see graph. for details)	3/4	%	97,3	97	97,1	96,5	96,9	97,2	97,6	97,3
	2/4	%	96,7	96,6	96,6	96	96,4	96,8	97	96,9
	1/4	%	95,6	95,9	95,7	95,1	95,6	96,2	96,2	96,2
Reactances (f. l.cl. F)	Xd	%	277,0	250	232,3	201	305	281,0	272,2	250
	Xd'	%	26,3	23,7	22,0	19,1	28,9	26,64	25,8	23,7
	Xd"	%	12,7	11,5	10,7	9,3	14	12,93	12,5	11,5
	Xq	%	196,1	177	164,4	142	216	198,9	192,7	177
	Xq'	%	196,1	177	164,4	142	216	198,9	192,7	177
	Xq"	%	27,7	25,0	23	20	30,5	28,1	27,2	25
	X <sub>2</sub>	%	18,0	16,2	15,1	13,1	20	18,21	17,6	16,2
	X <sub>0</sub>	%	4,0	3,6	3	2,6	4,4	4,05	3,9	3,6
Short Circuit Ratio	Kcc		0,36	0,40	0,43	0,49	0,33	0,36	0,37	0,40
Time Constants	Td'	sec.	0,275							
	Td"	sec.	0,024							
	Tdo'	sec.	12,5							
	Tα	sec.	0,034							
Short Circuit Current Capacity		%	>300				>350			
Excitation at no load	Amp.		0,8	0,9	1	1,1	0,5	0,6	0,75	0,85
Excitation at full load	Amp.		3	3,1	3,2	3,3	2,9	2,8	2,9	3
Overload (long-term)	%	1 hour in a 6 hours period 110% rated load								
Overload per 20 sec.	%	300								
Stator Winding Resistance (20°C)	Ω	0,0024								
Rotor Winding Resistance (20°C)	Ω	4,500								
Exciter Resistance (20 °C)	Ω	Rotor : 0,120				Stator : 12,90				
Heat dissipation at f.l.cl.H	W	63983	66116	70393	68116	71405	70268	69136	71679	
Telephone Interference		THF < 2%				TIF < 40				
Radio interference		EN61000-6-3, EN61000-6-2. For others standards apply to factory								
Waveform Distors.(THD) at f. load	LL/LN %	2,8 / 2,6								
Waveform Distors.(THD) at no load	LL/LN %	2,7 / 2,8								
<b>Mechanical characteristics</b>										
Protection		IP 21 (other protection on request)								
DE bearing		6330								
NDE bearing		6324								
Weight of wound stator assembly	kg	2034								
Weight of wound rotor assembly	kg	1216								
Weight of complete generator	kg	4380								
Maximun overspeed	rpm	2250								
Unbalanced magnetic pull at f.l.cl.F	kN/mm	7								
Cooling air requirement	m³/min	135				162				
Inertia Constant (H)	sec.	0,299				0,359				
Noise level at 1m/7m	dB(A)	97 / 86				100 / 91				

All technical data are to be considered as a reference and they can be modified without any notice.

This document is a propriety of Mecc Alte S.p.A.. All rights reserved.

**50 Hz**

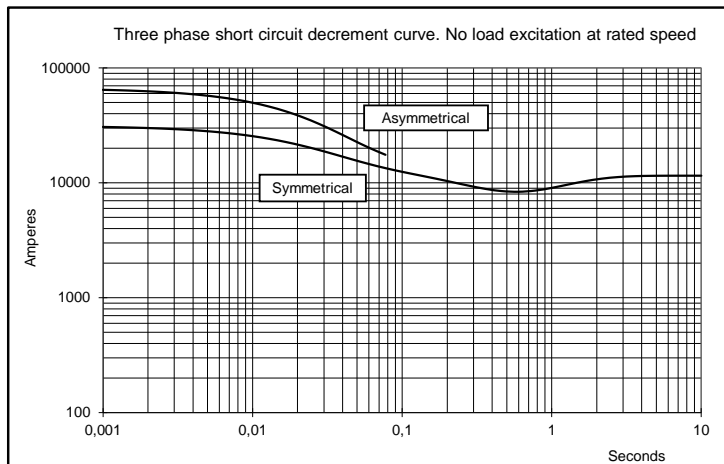
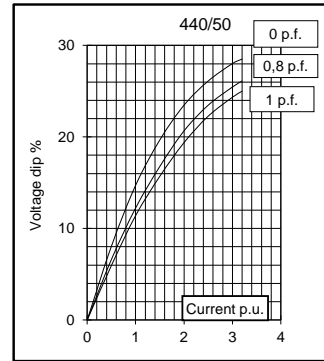
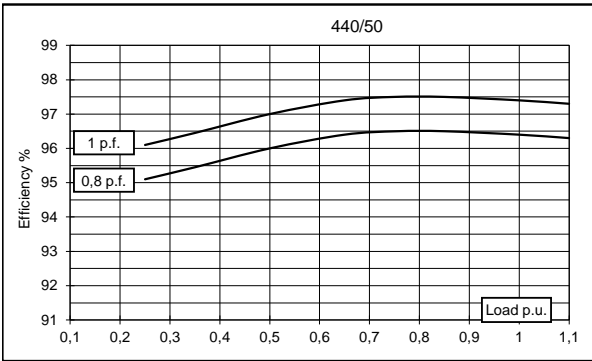
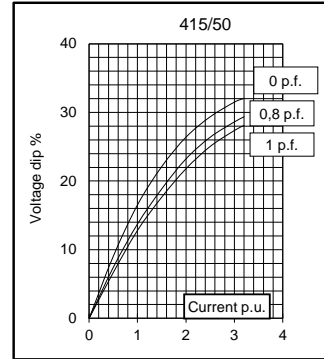
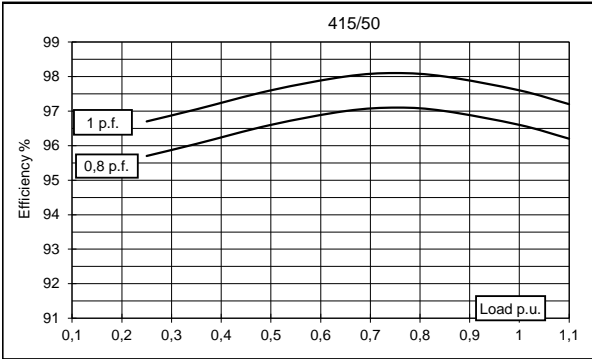
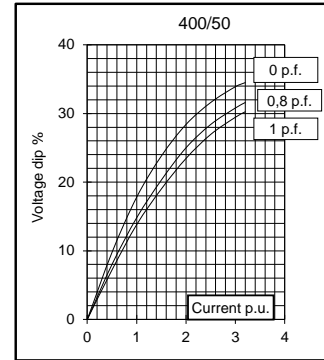
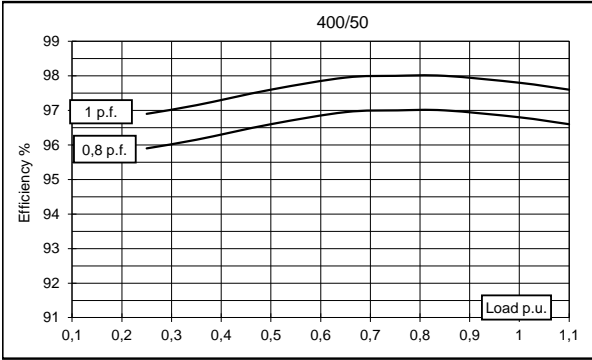
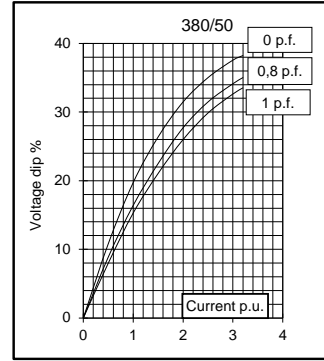
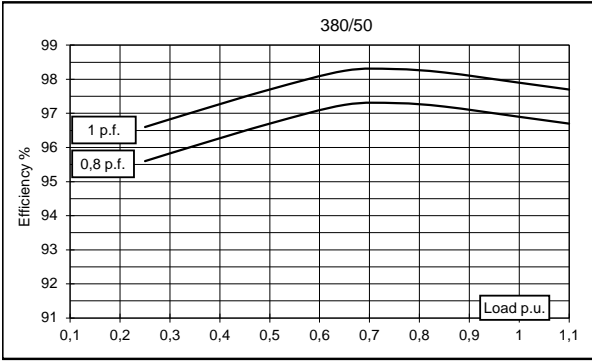

**60 Hz**

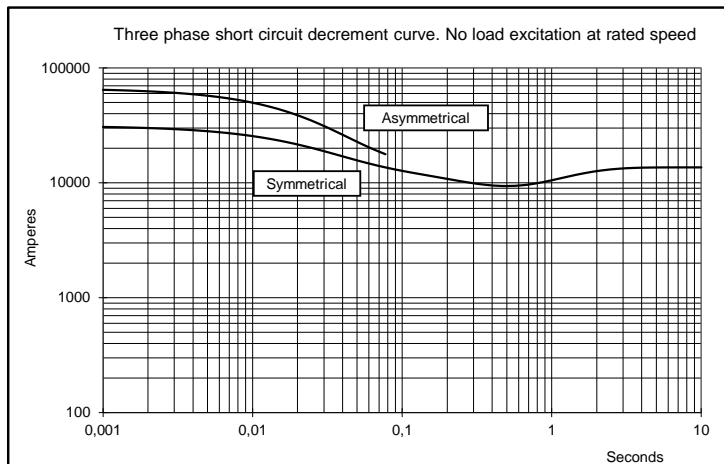
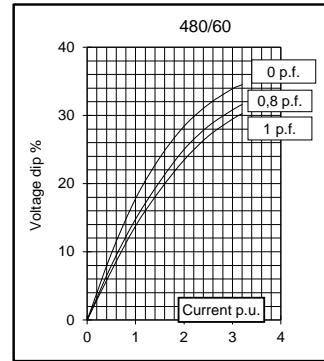
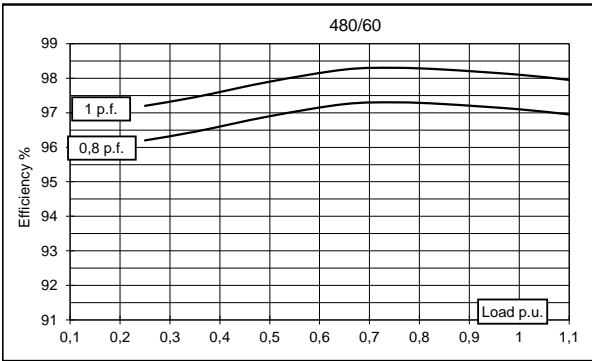
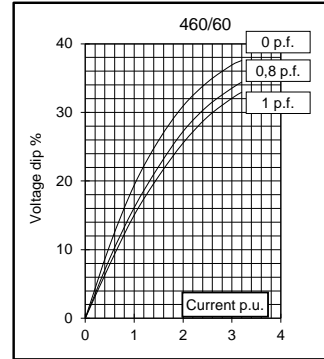
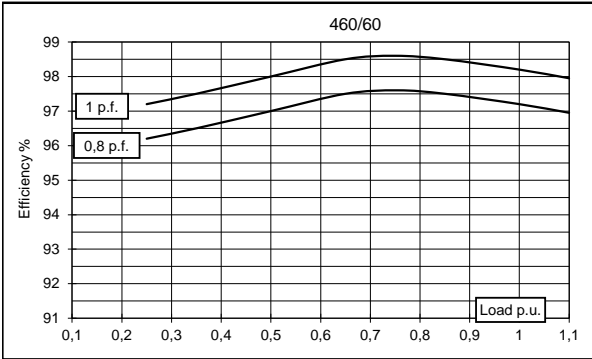
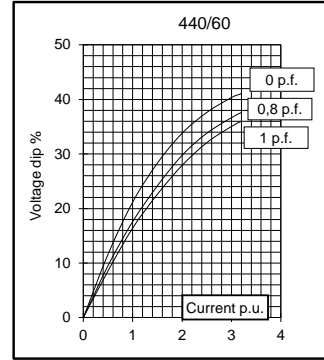
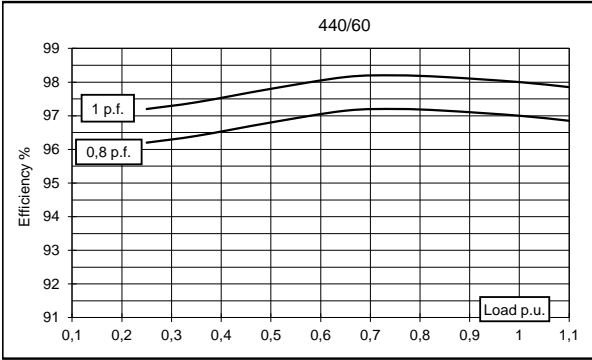
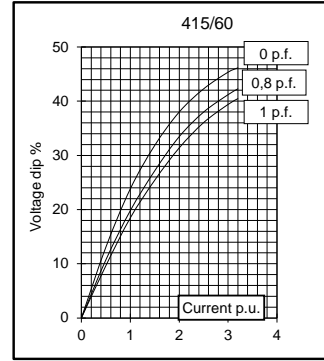
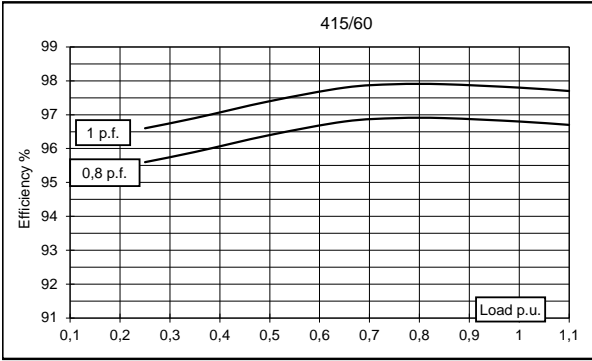

## TWO BEARING MOMENTS OF INERTIA

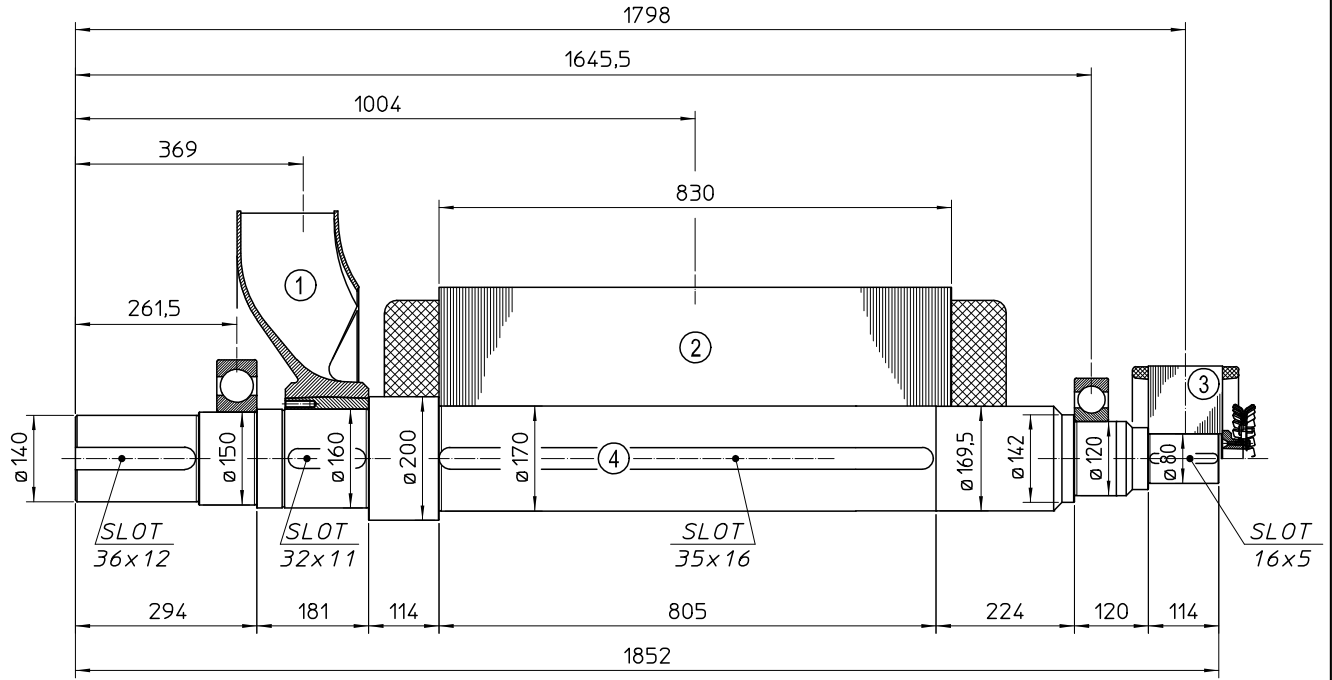

POS.	COMPONENT	WEIGHT (kg)	J (kgm <sup>2</sup> )
1	FAN	42.7	2.250
2	MAIN ROTOR	1216	47.366
3	EX. ROTOR	60	0.730
4	SHAFT	288	0.985
TOTAL		1606.7	51.331

## TWO BEARING DIMENSIONS

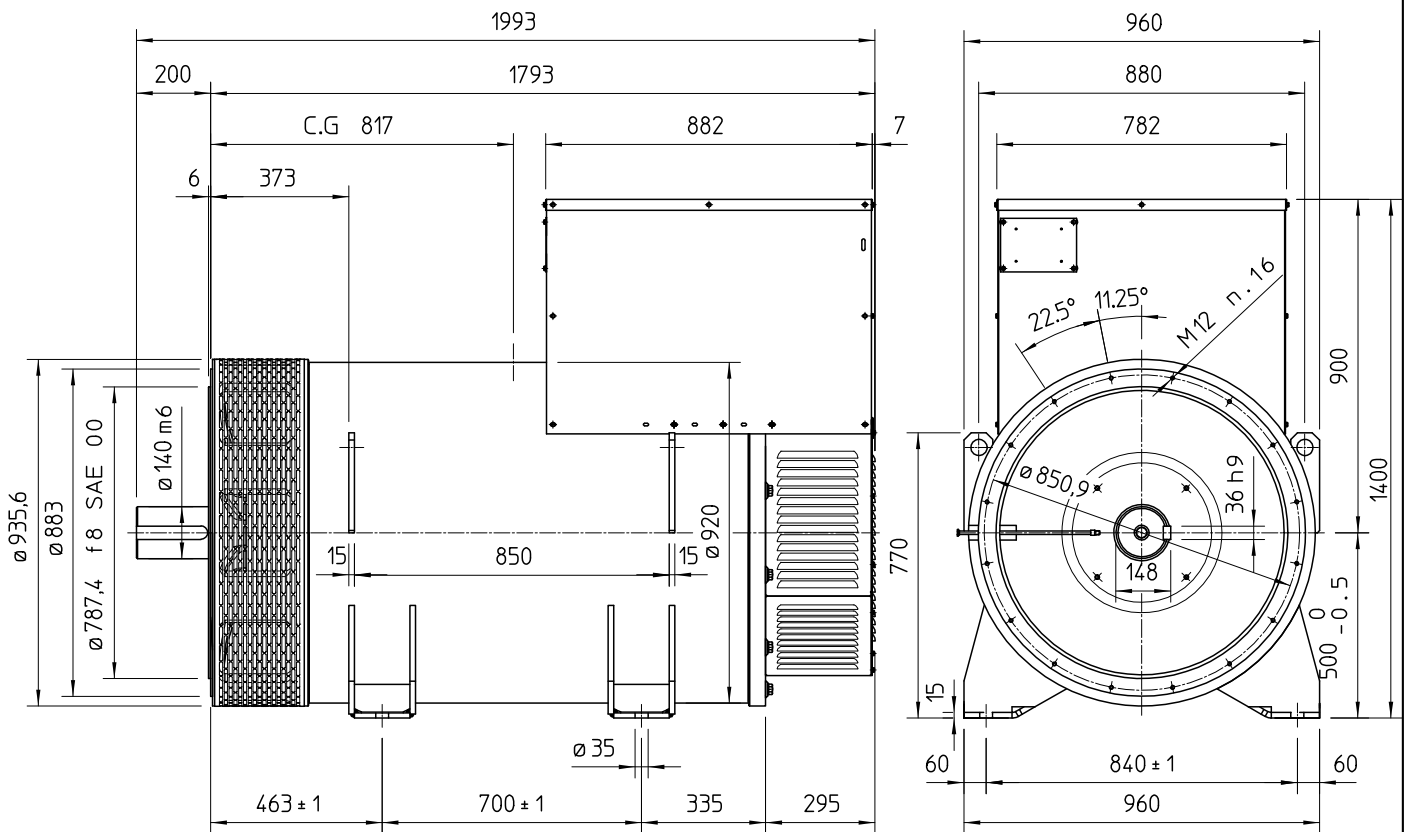

C.G.= GRAVITY CENTER

### SINGLE BEARING MOMENTS OF INERTIA

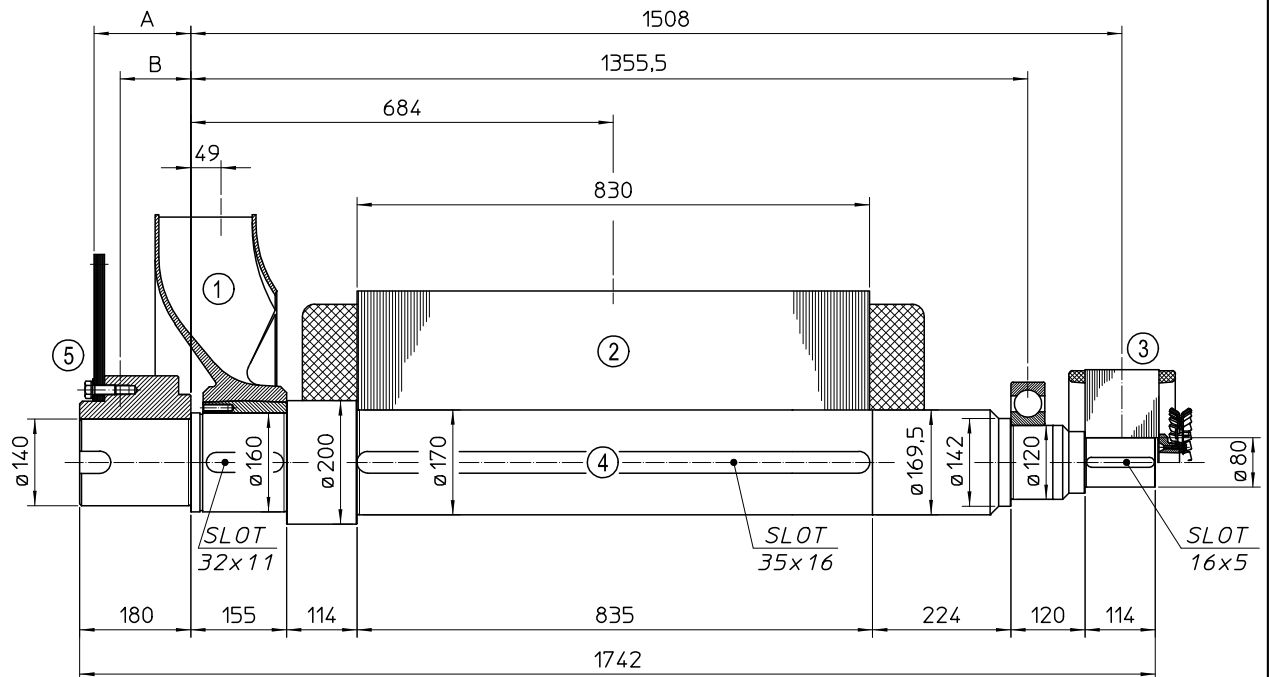

POS.	COMPONENT	WEIGHT (kg)	J (kgm <sup>2</sup> )
1	FAN	42.7	2,250
2	MAIN ROTOR	1216	47.366
3	EX. ROTOR	60	0,730
4	SHAFT	269.5	0.934
TOTAL		1588.2	51.28

SAE N°	5		SHAFTS COUPLING FLEX PLATE	
	A	B	WEIGHT kg	J kgm <sup>2</sup>
18	172.7	113.4	82.7	1.863
21	157	114.6	93,6	3,206

### SINGLE BEARING DIMENSIONS

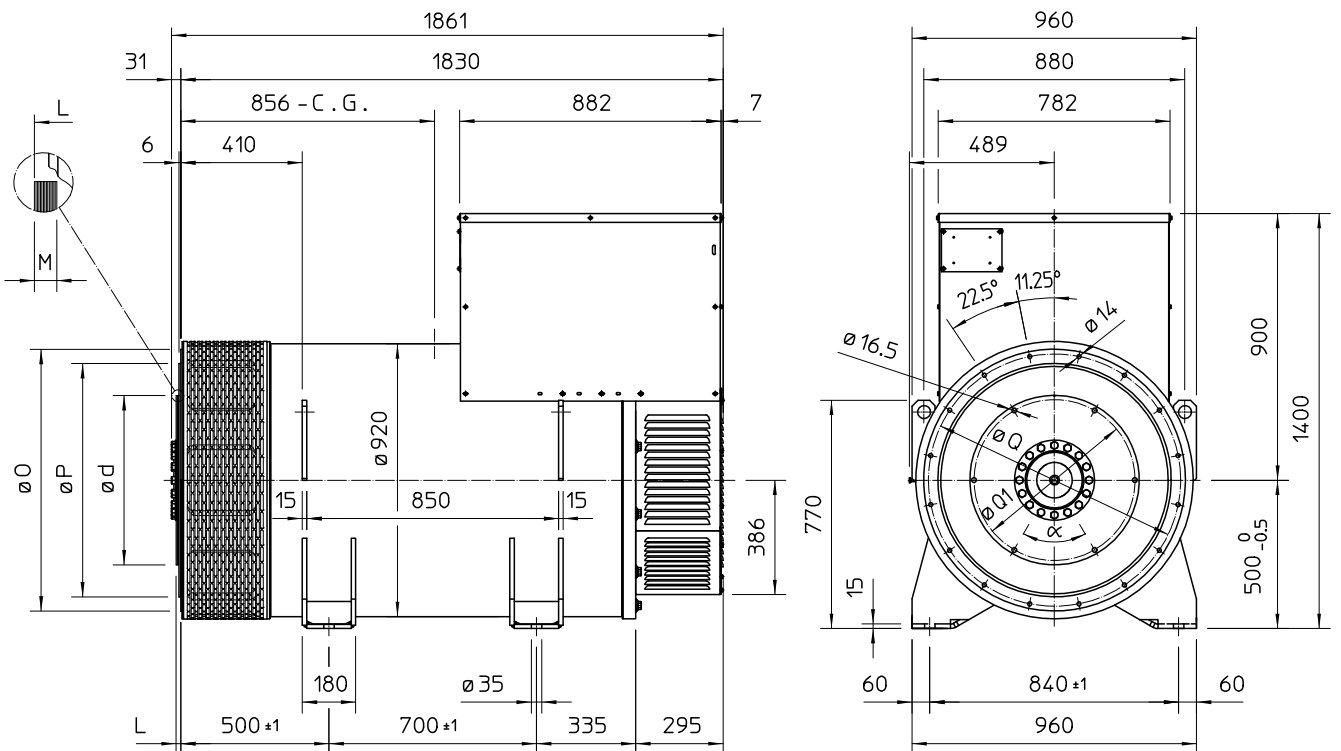

SAE N°	FLANGE		
	O	P	Q
0	711	647.7	679.5
00	883	787.4	850.9

SAE N°	DISC COUPLING						
	d	L	M	Q1	HOLES N°	α	
18	571.5	15.7	15	542.92	6	60°	
21	673.1	0	17	641.35	12	30°	

C.G.= GRAVITY CENTER