



GENERATOR TYPE ECO 40-3S/4

Document : DS024A/1

issue 010 date 21/03/2014

Electrical Characteristics										
Frequency	Hz	50				60				
Voltage (parallel star)	V	380	400	415	440	415	440	460	480	
Rated power class H	kVA	500	500	500	460	540	580	600	600	
	kW	400	400	400	368	432	464	480	480	
Rated power class F	kVA	450	450	450	414	484	520	540	540	
	kW	360	360	360	331	387	416	432	432	
Regulation with	DER1	±1% with any power factor and speed variations between -5% +30%								
Insulation class		H								
Execution		Brushless								
Stator winding		12 ends (nameplate data : 800V-50Hz Series Star, 960V-60Hz Series Star)								
Rotor		with damping cage								
Efficiencies class H	4/4	%	94,4	94,6	94,5	94,2	95	95,3	95,5	95,6
(see graph. for details)	3/4	%	94,6	94,8	94,7	94,4	95,2	95,5	95,7	95,8
	2/4	%	93,7	93,9	93,7	93,4	93,9	94,5	94,7	94,9
	1/4	%	90,2	90,3	90,1	89,8	90,5	90,7	90,9	91,1
Reactances (f. l.cl. F)										
	Xd	%	322	250	167	105	430	370	322	250
	Xd'	%	21,8	21	19,4	18,4	23,5	22,9	21,8	21
	Xd''	%	12,1	11,4	10,2	9,7	14,1	13,4	12,1	11,4
	Xq	%	122	108	102	92	145	136	122	108
	Xq'	%	122	108	102	92	145	136	122	108
	Xq''	%	27,7	26,4	25,8	24,3	29,5	28,6	27,7	26,4
	X ₂	%	18,4	16,7	15,7	13,8	20,2	19,4	18,4	16,7
	X ₀	%	3,2	3	2,7	2,5	3,8	3,6	3,2	3
Short Circuit Ratio	Kcc		0,31	0,40	0,60	0,96	0,23	0,27	0,31	0,40
Time Constants										
	Td'	sec.	0,14							
	Td''	sec.	0,021							
	Tdo'	sec.	2,80							
	Tα	sec.	0,031							
Short Circuit Current Capacity										
		%	>300				>350			
Excitation at no load	Amp.		0,6	0,7	1	1,2	0,4	0,5	0,6	0,7
Excitation at full load	Amp.		3,6	3,5	3,9	4	3	3,1	3,2	3,4
Overload (long-term)	%	1 hour in a 6 hours period 110% rated load								
Overload per 20 sec.	%	300								
Stator Winding Resistance (20°C)	Ω	0,0106								
Rotor Winding Resistance (20°C)	Ω	5,176								
Exciter Resistance (20 °C)	Ω	Rotor : 0,317				Stator : 8,85				
Heat dissipation at f.l.cl.H	W	23729	22833	23280	22658	22737	22884	22618	22092	
Telephone Interference		THF < 2%				TIF < 40				
Radio interference		EN61000-6-3, EN61000-6-2. For others standards apply to factory								
Waveform Distors.(THD) at f. load	LL/LN %	2,4 / 2,5								
Waveform Distors.(THD) at no load	LL/LN %	2,6 / 2,5								
Mechanical characteristics										
Protection		IP 21 (other protection on request)								
DE bearing		6322								
NDE bearing		6318.2RS								
Weight of wound stator assembly	kg	428								
Weight of wound rotor assembly	kg	274,6								
Weight of complete generator	kg	1171								
Maximun overspeed	rpm	2250								
Unbalanced magnetic pull at f.l.cl.F	kN/mm	6,5								
Cooling air requirement	m ³ /min	54				64,8				
Inertia Constant (H)	sec.	0,175				0,210				
Noise level at 1m/7m	dB(A)	94 / 82				98 / 88				

All technical data are to be considered as a reference and they can be modified without any notice.

This document is a propriety of Mecc Alte S.p.A.. All rights reserved.

50 Hz

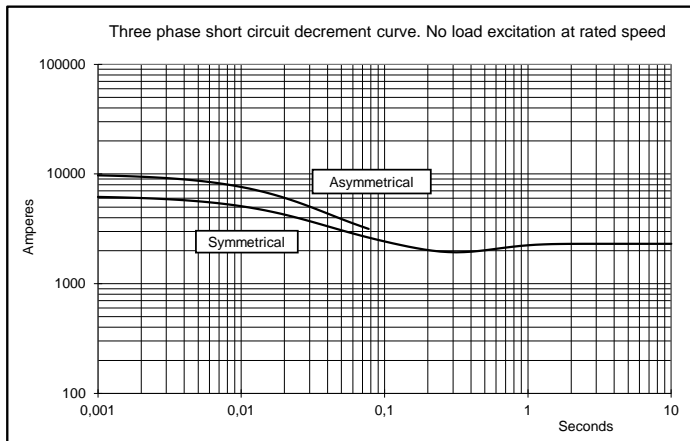
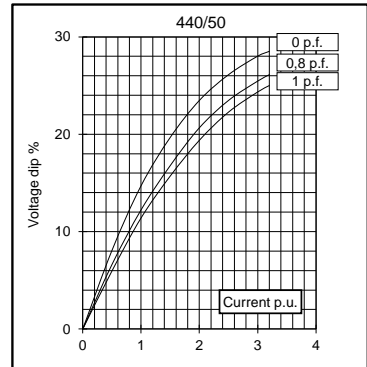
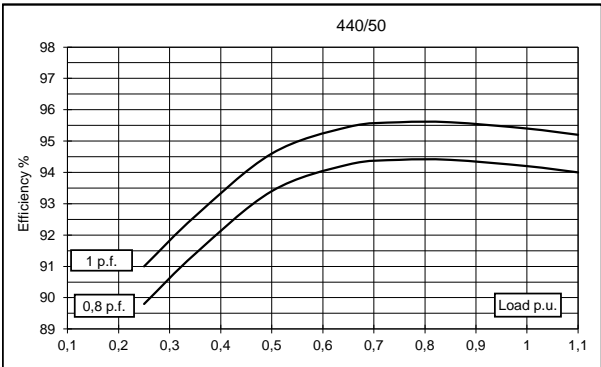
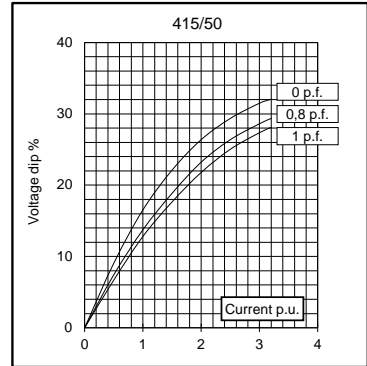
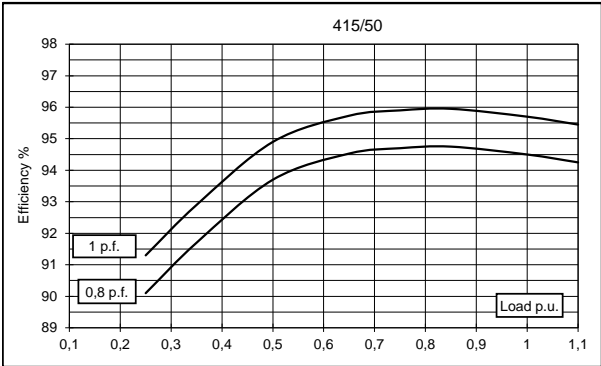
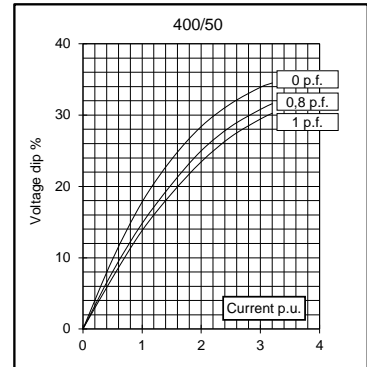
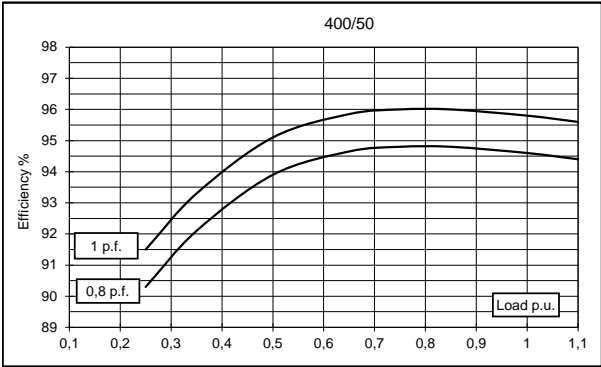
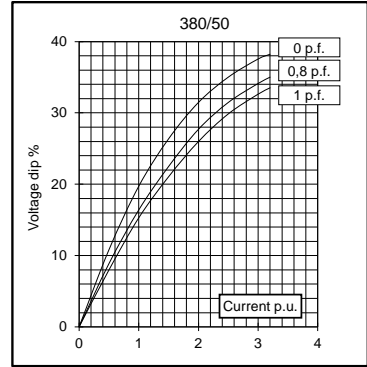
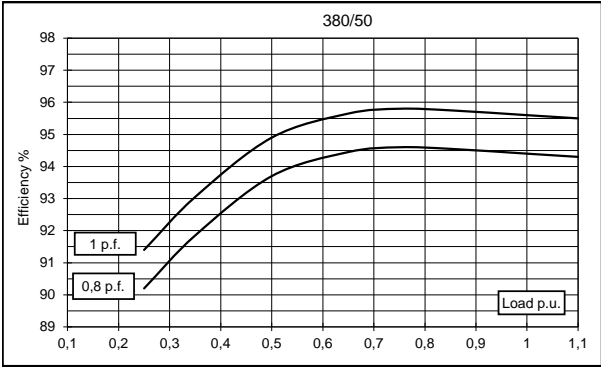



60 Hz

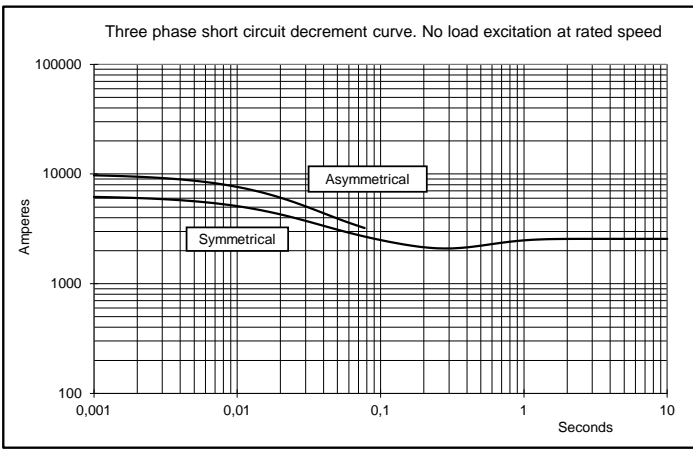
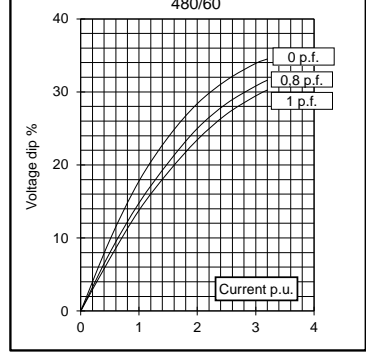
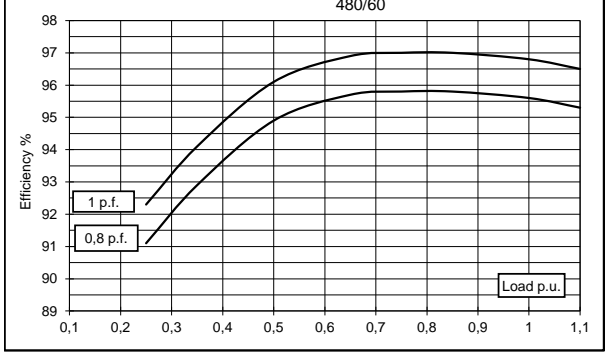
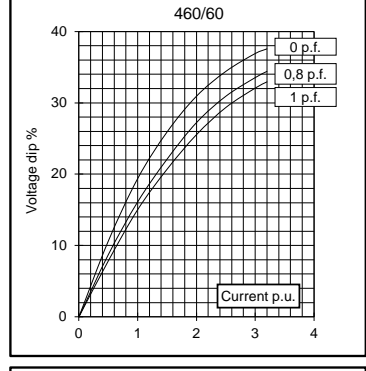
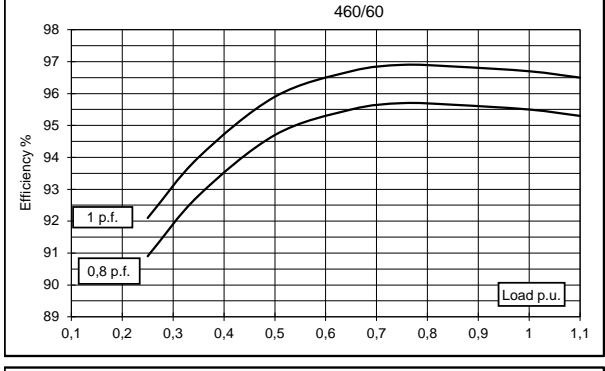
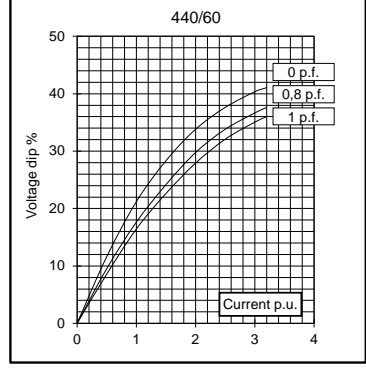
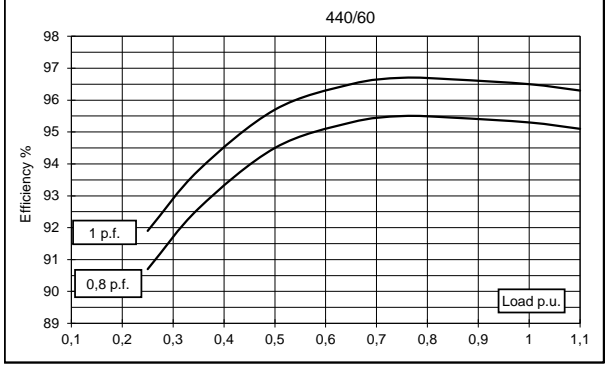
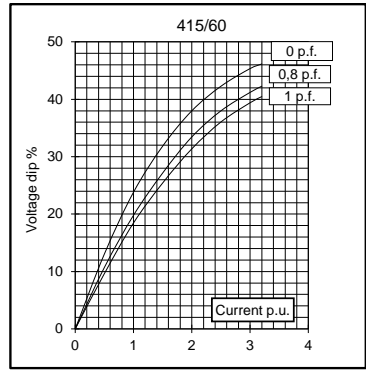
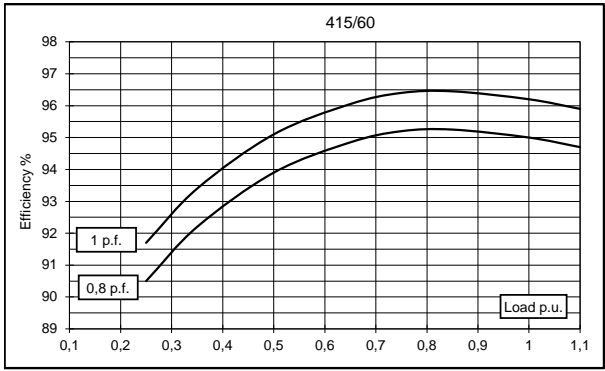

TWO BEARING MOMENTS OF INERTIA

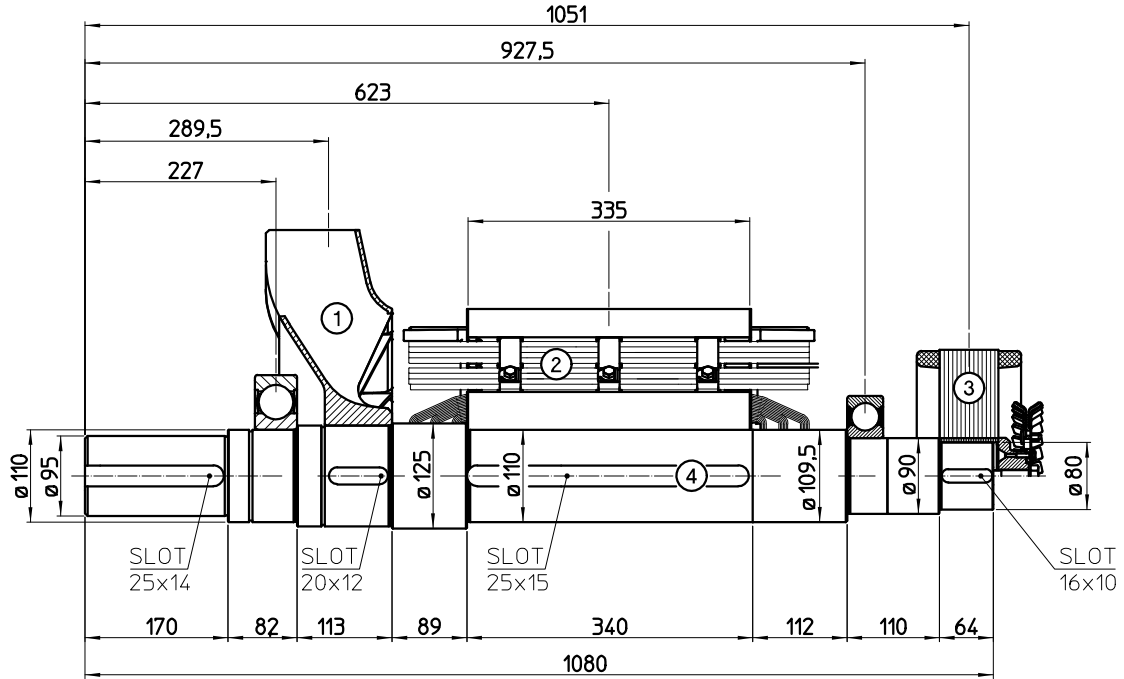

COMPONENT	WEIGHT kg	J kgm ²
1 FAN	10,2	0,335
2 MAIN ROTOR	274,6	5,846
3 EX. ROTOR	35	0,562
4 SHAFT	73,6	0,109
TOTAL	393,4	6,852

TWO BEARING DIMENSIONS

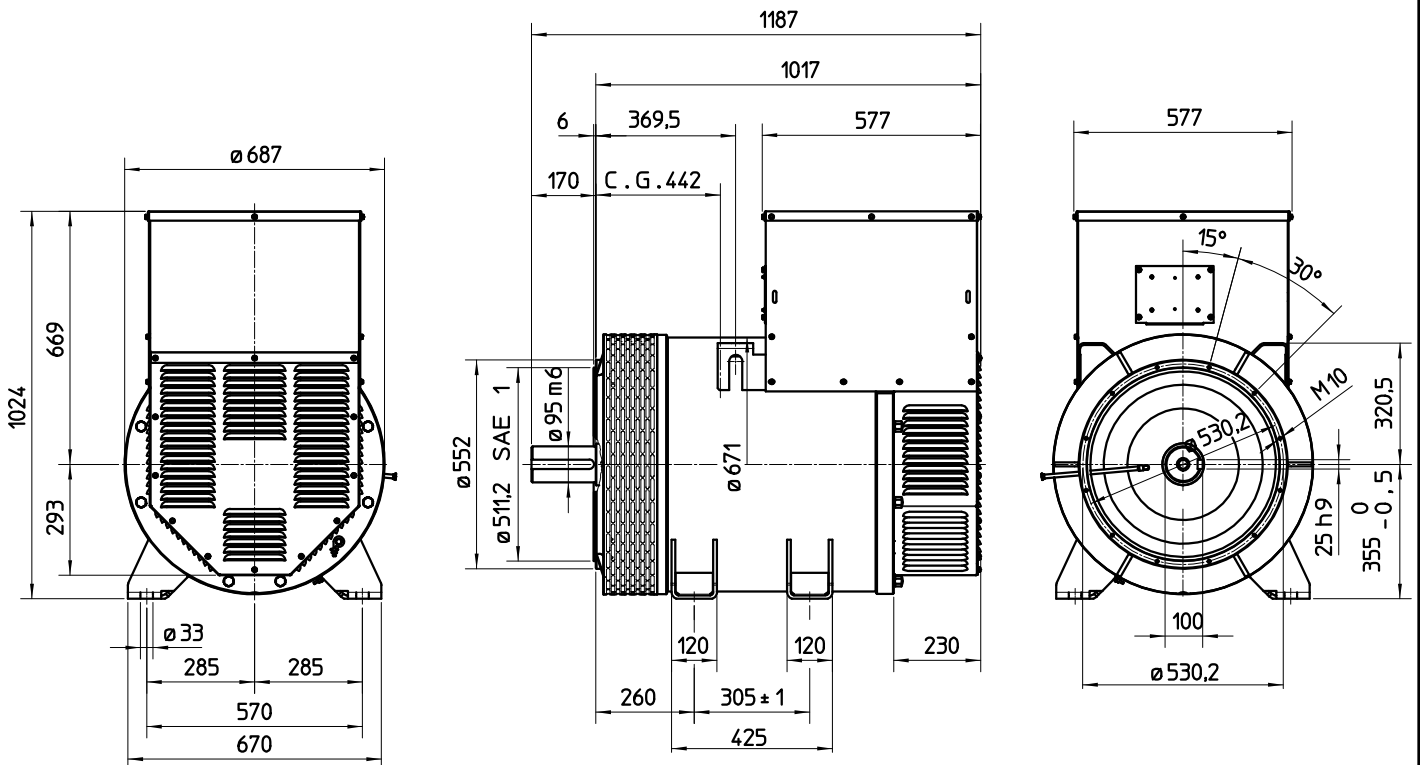

C.G.= GRAVITY CENTER

SINGLE BEARING MOMENTS OF INERTIA

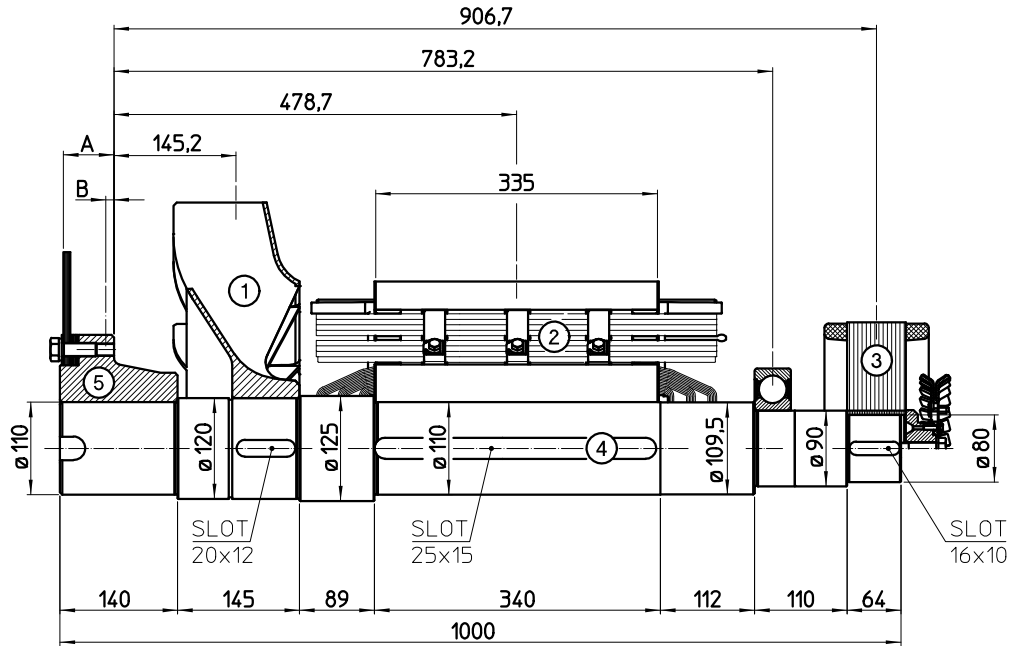

COMPONENT	WEIGHT kg	J kgm ²
1 FAN	10,2	0,335
2 MAIN ROTOR	274,6	5,846
3 EX. ROTOR	35	0,562
4 SHAFT	72	0,111
TOTAL	391,8	6,854

Sae No	SHAFTS COUPLING FLEX PLATE		
	A	B	WEIGHT kg
14	60	9,6	41,4
18	50	6,6	45,1

SINGLE BEARING DIMENSIONS

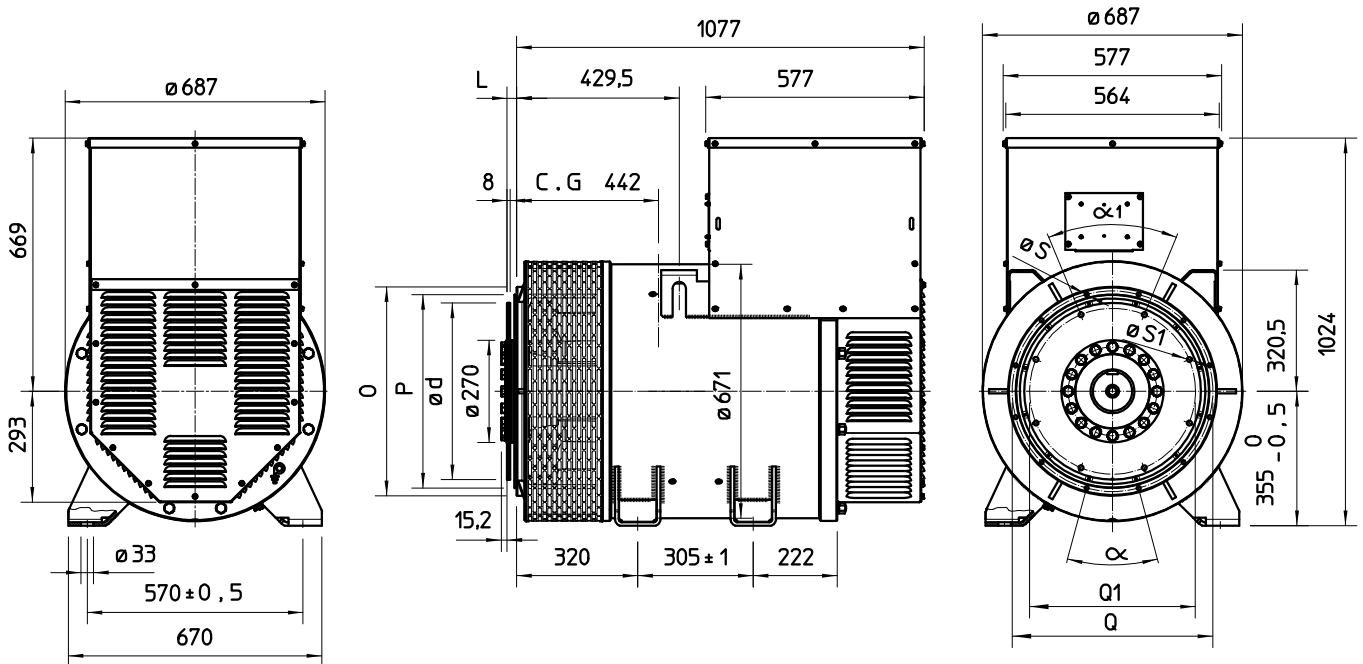

SAE N.	FLANGIA / FLANGE BRIDE / FLANSCH					
	O	P	Q	N. FORI	S	α
1	552	511,2	530,2	12	11	30°
1/2	648	584,2	619,1	12	14	30°
0	711	647,7	679,5	16	14	22,5°
00	883	787,4	850,9	16	14	22,5°

VOL. N.	GIUNTI A DISCHI / DISC COUPLING DISQUE DE MONOPALIER / SCHEIBENKUPPLUNG					
	L	d	Q1	N. FORI	S1	α1
14	25,4	466,72	438,15	8	14	45°
18	15,7	571,5	542,92	6	17	60°

C.G.= GRAVITY CENTER