

| <b>Electrical Characteristics</b>    |                     |   |   |       |       |       |               |       |       |       |
|--------------------------------------|---------------------|---|---|-------|-------|-------|---------------|-------|-------|-------|
| Frequency                            | Hz                  | 50  |   |       |       | 60    |               |       |       |       |
| Voltage (parallel star)              | V                   | 380   | 400   | 415   | 440   | 415   | 440           | 460   | 480   |       |
| Rated power class H                  | kVA                 | 680   | 680   | 680   | 630   | 720   | 780           | 816   | 816   |       |
|                                      | kW                  | 544   | 544   | 544   | 504   | 576   | 624           | 653   | 653   |       |
| Rated power class F                  | kVA                 | 630   | 630   | 630   | 585   | 665   | 720           | 756   | 756   |       |
|                                      | kW                  | 504   | 504   | 504   | 468   | 532   | 576           | 605   | 605   |       |
| Regulation with                      | DER1                | ±1% with any power factor and speed variations between -5% +30% |   |       |       |       |               |       |       |       |
| Insulation class                     |                     | H   |   |       |       |       |               |       |       |       |
| Execution                            |                     | Brushless   |   |       |       |       |               |       |       |       |
| Stator winding                       |                     | 12 ends   |   |       |       |       |               |       |       |       |
| Rotor                                |                     | with damping cage   |   |       |       |       |               |       |       |       |
| Efficiencies class H                 | 4/4                 | %   | 94,8  | 95    | 94,7  | 94,4  | 95,7          | 96    | 96,2  | 96,4  |
| (see graph. for details)             | 3/4                 | %   | 95  | 95,2  | 95    | 94,6  | 95,8          | 96,1  | 96,4  | 96,6  |
|                                      | 2/4                 | %   | 94,1  | 94,3  | 94,2  | 94    | 94,8          | 95    | 95,2  | 95,5  |
|                                      | 1/4                 | %   | 91,4  | 91,5  | 91,3  | 91    | 91,4          | 91,5  | 91,7  | 92,1  |
| <b>Reactances (f. l.cl. F)</b>       |                     |   |   |       |       |       |               |       |       |       |
|                                      | Xd                  | %   | 312   | 227   | 150   | 97    | 410           | 355   | 312   | 227   |
|                                      | Xd'                 | %   | 19,4  | 18,1  | 17,2  | 16,4  | 21,8          | 20,6  | 19,4  | 18,1  |
|                                      | Xd''                | %   | 10,6  | 9,2   | 8,7   | 8,1   | 11,9          | 11,1  | 10,6  | 9,2   |
|                                      | Xq                  | %   | 165   | 141   | 133   | 127   | 194           | 181   | 165   | 141   |
|                                      | Xq'                 | %   | 165   | 141   | 133   | 127   | 194           | 181   | 165   | 141   |
|                                      | Xq''                | %   | 17,1  | 16,2  | 14,7  | 12,5  | 19,6          | 18,2  | 17,1  | 16,2  |
|                                      | X <sub>2</sub>      | %   | 15,2  | 14,1  | 12,5  | 11,2  | 17,4          | 16,6  | 15,2  | 14,1  |
|                                      | X <sub>0</sub>      | %   | 2,60  | 2,4   | 2,20  | 2,10  | 3,20          | 2,90  | 2,6   | 2,4   |
| Short Circuit Ratio                  | Kcc                 |   | 0,32  | 0,44  | 0,67  | 1,10  | 0,24          | 0,28  | 0,32  | 0,44  |
| Time Constants                       | Td'                 | sec.  | 0,18  |       |       |       |               |       |       |       |
|                                      | Td''                | sec.  | 0,019   |       |       |       |               |       |       |       |
|                                      | Tdo'                | sec.  | 3,10  |       |       |       |               |       |       |       |
|                                      | Tα                  | sec.  | 0,052   |       |       |       |               |       |       |       |
| Short Circuit Current Capacity       |                     | %   | >300  |       |       |       | >350          |       |       |       |
| Excitation at no load                | Amp.                |   | 0,6   | 0,7   | 1     | 1,2   | 0,4           | 0,5   | 0,6   | 0,7   |
| Excitation at full load              | Amp.                |   | 4,3   | 4,4   | 4,7   | 4,9   | 3,5           | 3,6   | 3,7   | 3,9   |
| Overload (long-term)                 |                     | %   | 1 hour in a 6 hours period 110% rated load                      |       |       |       |               |       |       |       |
| Overload per 20 sec.                 |                     | %   | 300   |       |       |       |               |       |       |       |
| Stator Winding Resistance (20°C)     | Ω                   |   | 0,013   |       |       |       |               |       |       |       |
| Rotor Winding Resistance (20°C)      | Ω                   |   | 1,5   |       |       |       |               |       |       |       |
| Exciter Resistance (20 °C)           | Ω                   |   | Rotor : 0,050   |       |       |       | Stator : 8,85 |       |       |       |
| Heat dissipation at f.l.cl.H         | W                   |   | 29840   | 28632 | 30446 | 29898 | 25881         | 26000 | 25786 | 24378 |
| Telephone Interference               |                     |   | THF < 2%  |       |       |       | TIF < 40      |       |       |       |
| Radio interference                   |                     |   | EN61000-6-3, EN61000-6-2. For others standards apply to factory |       |       |       |               |       |       |       |
| Waveform Distors.(THD) at f. load    | LL/LN %             |   | 2,1 / 2,1   |       |       |       |               |       |       |       |
| Waveform Distors.(THD) at no load    | LL/LN %             |   | 2,4 / 2,4   |       |       |       |               |       |       |       |
| <b>Mechanical characteristics</b>    |                     |   |   |       |       |       |               |       |       |       |
| Protection                           |                     |   | IP 21 (other protection on request )                            |       |       |       |               |       |       |       |
| DE bearing                           |                     |   | 6322  |       |       |       |               |       |       |       |
| NDE bearing                          |                     |   | 6318.2RS  |       |       |       |               |       |       |       |
| Weight of wound stator assembly      | kg                  |   | 641   |       |       |       |               |       |       |       |
| Weight of wound rotor assembly       | kg                  |   | 386,7   |       |       |       |               |       |       |       |
| Weight of complete generator         | kg                  |   | 1586  |       |       |       |               |       |       |       |
| Maximun overspeed                    | rpm                 |   | 2250  |       |       |       |               |       |       |       |
| Unbalanced magnetic pull at f.l.cl.F | kN/mm               |   | 6,8   |       |       |       |               |       |       |       |
| Cooling air requirement              | m <sup>3</sup> /min |   | 54  |       |       |       | 64,8          |       |       |       |
| Inertia Constant (H)                 | sec.                |   | 0,172   |       |       |       | 0,207         |       |       |       |
| Noise level at 1m/7m                 | dB(A)               |   | 94 / 82   |       |       |       | 98 / 88       |       |       |       |

All technical data are to be considered as a reference and they can be modified without any notice.

This document is a propriety of Mecc Alte S.p.A.. All rights reserved.



GENERATOR TYPE ECO 40-2L/4

Document : DS026A/2  
 issue 009 date : 21/03/2014

**50 Hz**

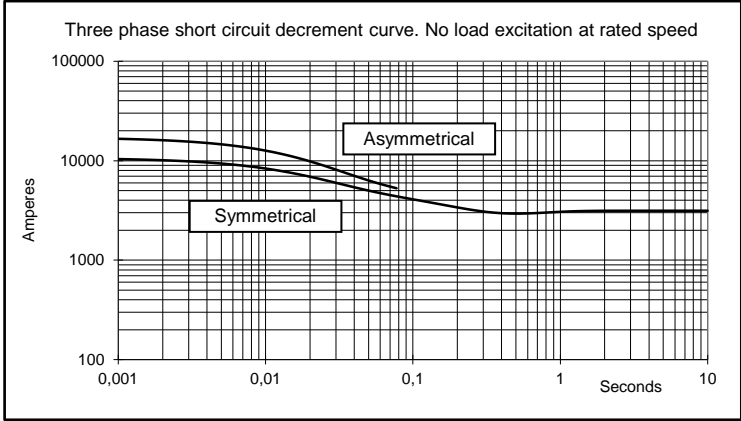
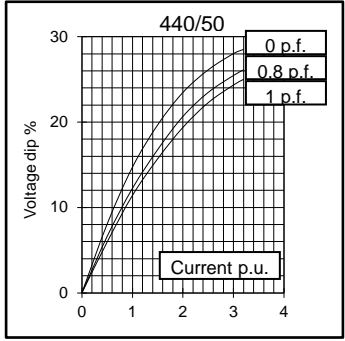
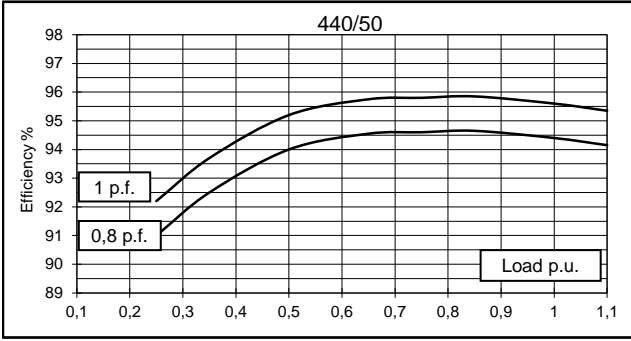
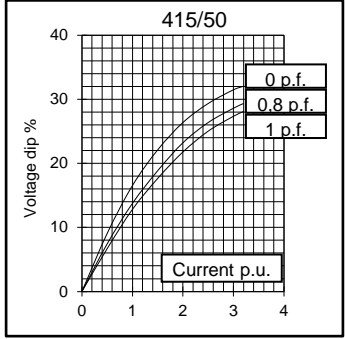
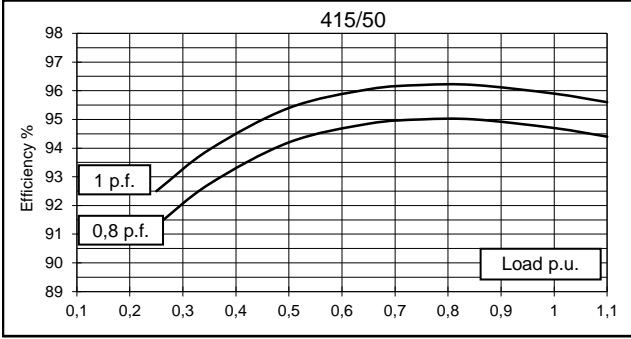
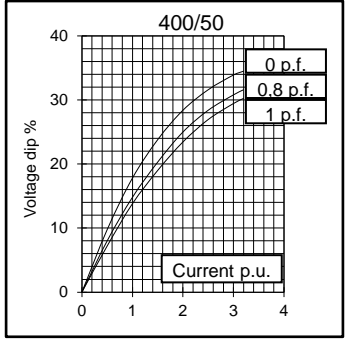
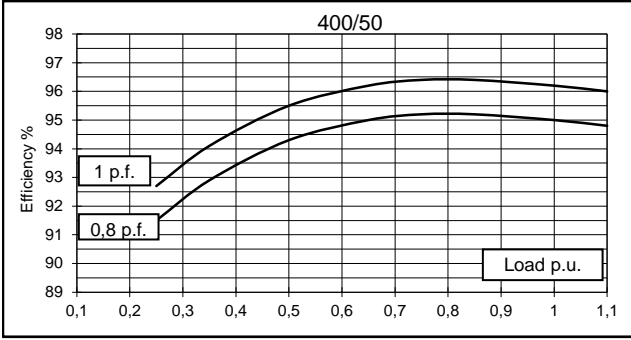
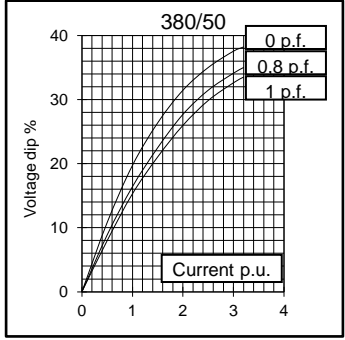
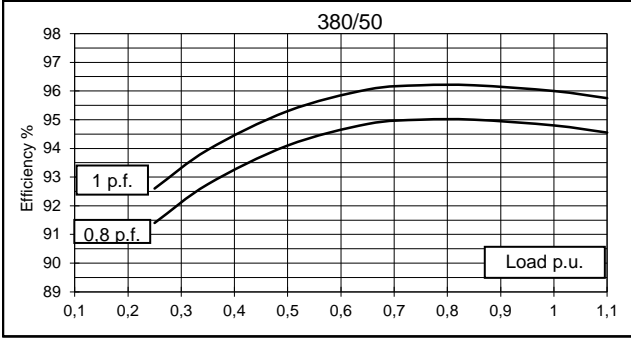



GENERATOR TYPE ECO 40-2L/4

Document : DS026A/3  
 issue 009 date : 21/03/2014

**60 Hz**

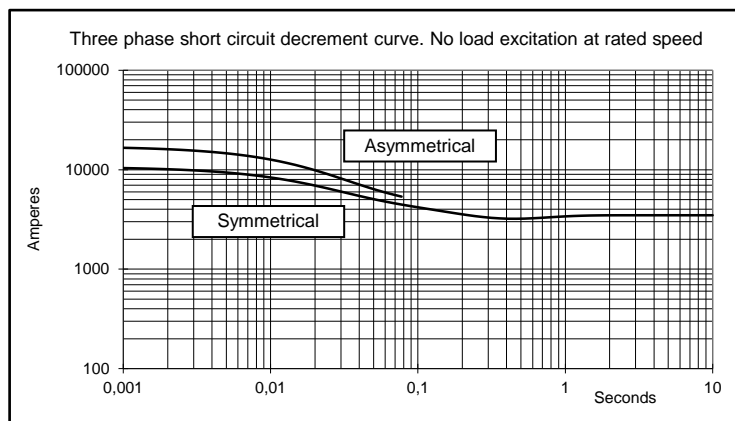
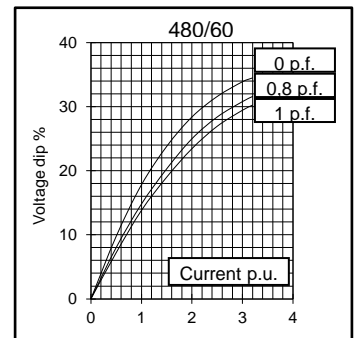
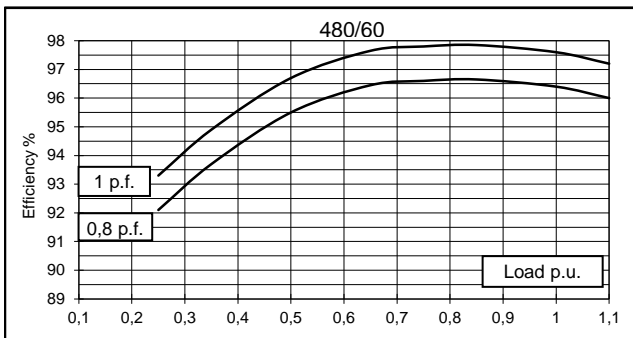
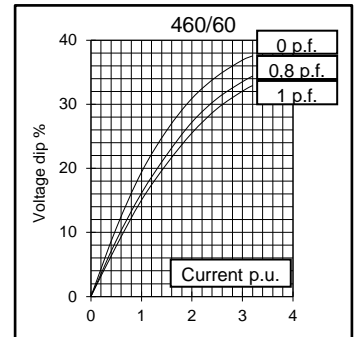
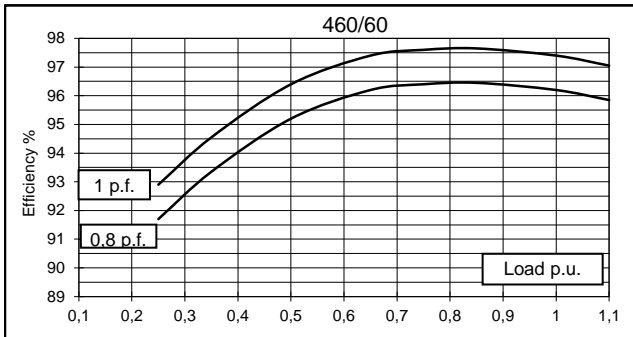
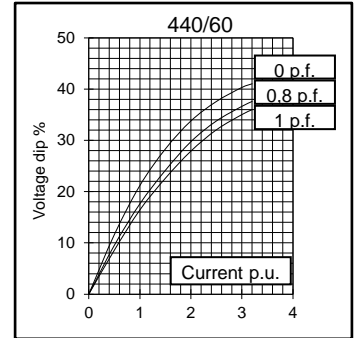
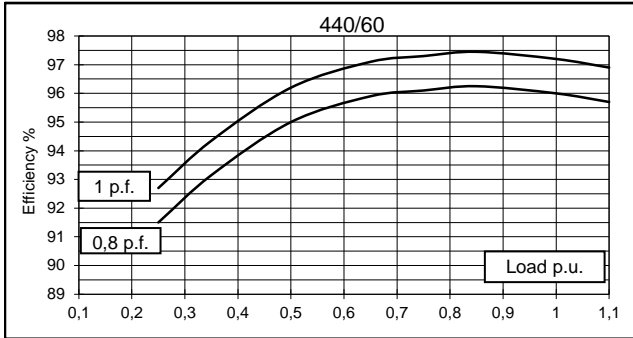
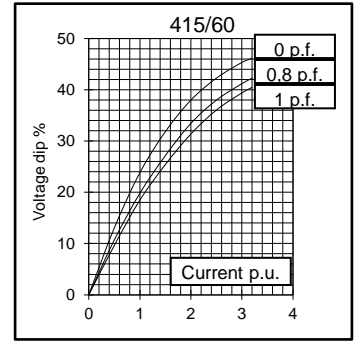
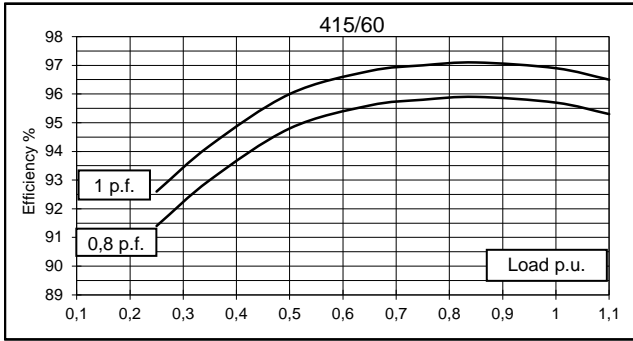



SINGLE BEARING MOMENTS OF INERTIA

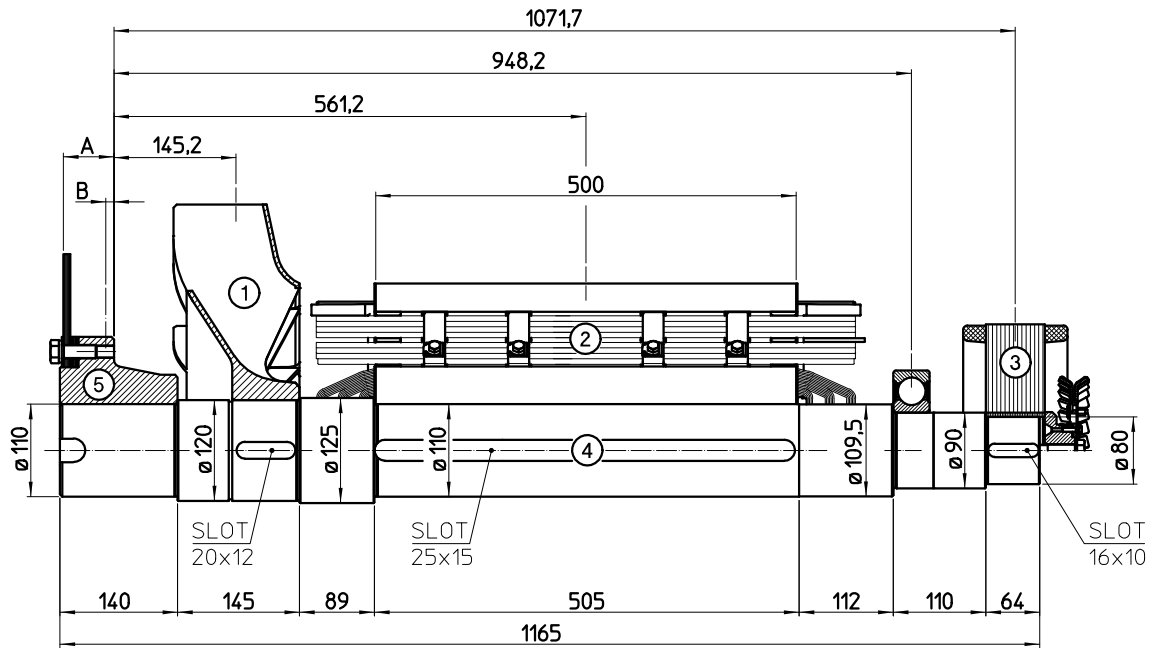

| COMPONENT    | WEIGHT kg | J kgm <sup>2</sup> |
|--------------|-----------|--------------------|
| 1 FAN        | 10,2      | 0,335              |
| 2 MAIN ROTOR | 386,7     | 8,234              |
| 3 EX. ROTOR  | 35        | 0,562              |
| 4 SHAFT      | 84,2      | 0,129              |
| TOTAL        | 516,1     | 9,26               |

| Sae No | SHAFTS COUPLING FLEX PLATE |     |           |                    |
|--------|----------------------------|-----|-----------|--------------------|
|        | A                          | B   | WEIGHT kg | J kgm <sup>2</sup> |
| 14     | 60                         | 9,6 | 41,4      | 0,511              |
| 18     | 50                         | 6,6 | 45,1      | 0,858              |

SINGLE BEARING DIMENSIONS

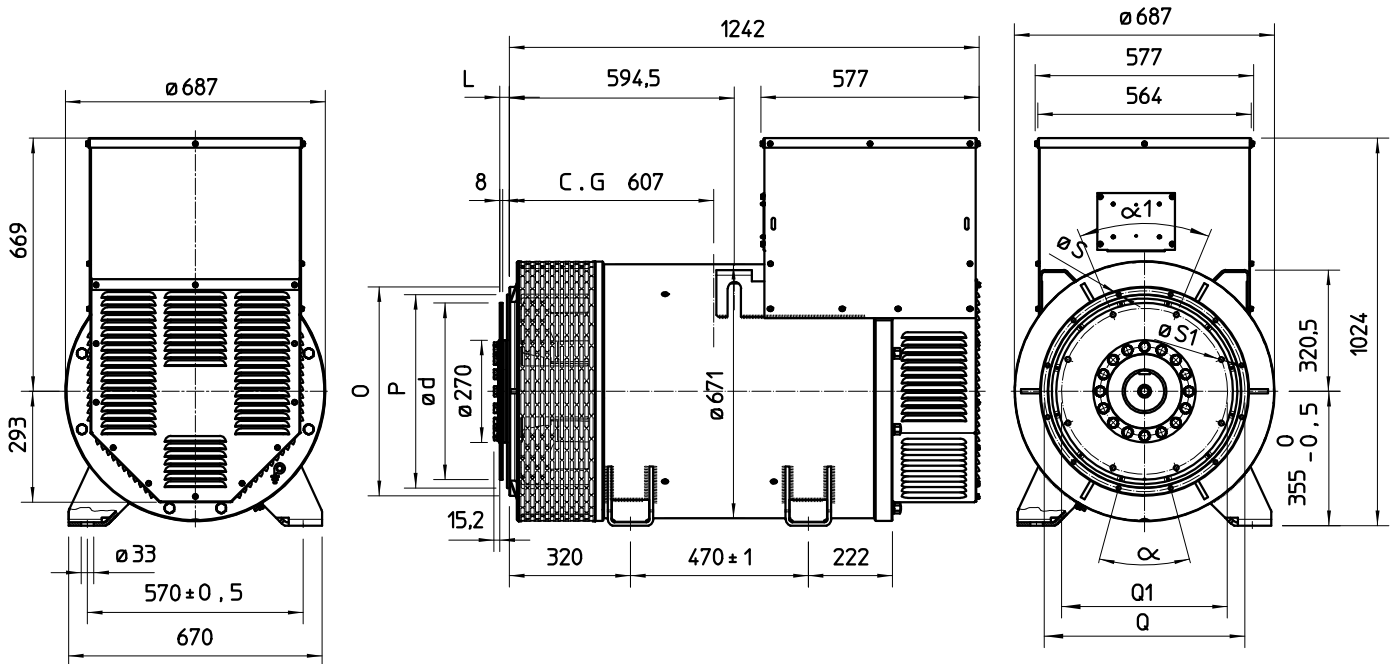

| SAE N. | FLANGIA / FLANGE BRIDE / FLANSCH |       |       |         |    |       |
|--------|----------------------------------|-------|-------|---------|----|-------|
|        | O                                | P     | Q     | N. FORI | S  | α     |
| 1      | 552                              | 511,2 | 530,2 | 12      | 11 | 30°   |
| 1/2    | 648                              | 584,2 | 619,1 | 12      | 14 | 30°   |
| 0      | 711                              | 647,7 | 679,5 | 16      | 14 | 22,5° |
| 00     | 883                              | 787,4 | 850,9 | 16      | 14 | 22,5° |

| VOL. N. | GIUNTI A DISCHI / DISC COUPLING DISCQUE DE MONOPALIER / SCHEIBENKUPPLUNG |        |        |         |    |     |  |
|---------|--|--------|--------|---------|----|-----|--|
|         | L  | d      | Q1     | N. FORI | S1 | α1  |  |
| 14      | 25,4   | 466,72 | 438,15 | 8       | 14 | 45° |  |
| 18      | 15,7   | 571,5  | 542,92 | 6       | 17 | 60° |  |

C.G.= GRAVITY CENTER