

<b>Electrical Characteristics</b>										
Frequency	Hz	50				60				
Voltage (parallel star)	V	380	400	415	440	415	440	460	480	
Rated power class H	kVA	400	400	400	370	420	450	480	480	
	kW	320	320	320	296	336	360	384	384	
Rated power class F	kVA	370	370	370	342	383	410	440	440	
	kW	296	296	296	274	306	328	352	352	
Regulation with	DER1	±1% with any power factor and speed variations between -5% +30%								
Insulation class		H								
Execution		Brushless								
Stator winding		12 ends								
Rotor		with damping cage								
Efficiencies class H	4/4	%	94,1	94,2	94	93,8	94,4	94,8	95,1	95,2
(see graph. for details)	3/4	%	94,2	94,4	94,1	93,9	94,5	94,9	95,2	95,3
	2/4	%	93,3	93,5	93,3	93,1	93,3	93,8	94	94,2
	1/4	%	89,1	89,3	89,2	89	90,4	90,6	90,8	91
Reactances (f. l.cl. F)	Xd	%	333	277	185	115	406	365	333	277
	Xd'	%	27,4	22,5	20,4	18,6	29,7	28,5	27,4	22,5
	Xd''	%	16,2	14,2	12,1	10,4	19,2	18,1	16,2	14,2
	Xq	%	121	112	104	97	145	131	121	112
	Xq'	%	121	112	104	97	145	131	121	112
	Xq''	%	29,4	28,2	26,7	24,2	31,7	30,6	29,4	28,2
	X <sub>2</sub>	%	19,7	18,5	17,2	15,6	21,8	20,4	19,7	18,5
	X <sub>0</sub>	%	3,7	3,5	3,1	2,7	4,1	3,9	3,7	3,5
Short Circuit Ratio	Kcc		0,30	0,36	0,55	0,90	0,24	0,27	0,30	0,36
Time Constants	Td'	sec.	0,16							
	Td''	sec.	0,019							
	Tdo'	sec.	2,55							
	Tα	sec.	0,017							
Short Circuit Current Capacity		%	>300				>350			
Excitation at no load	Amp.		0,7	0,8	0,9	1,1	0,5	0,6	0,7	0,8
Excitation at full load	Amp.		3,4	3,6	3,7	3,8	3,1	3,3	3,4	3,5
Overload (long-term)		%	1 hour in a 6 hours period 110% rated load							
Overload per 20 sec.		%	300							
Stator Winding Resistance (20°C)	Ω		0,018							
Rotor Winding Resistance (20°C)	Ω		4,488							
Exciter Resistance (20 °C)	Ω		Rotor : 0,317				Stator : 8,85			
Heat dissipation at f.l.cl.H	W		20064	19703	20426	19565	19932	19747	19785	19361
Telephone Interference			THF < 2%				TIF < 40			
Radio interference			EN61000-6-3, EN61000-6-2. For others standards apply to factory							
Waveform Distors.(THD) at f. load	LL/LN %		2,6 / 2,6							
Waveform Distors.(THD) at no load	LL/LN %		2,9 / 2,9							
<b>Mechanical characteristics</b>										
Protection			IP 21 (other protection on request )							
DE bearing			6322							
NDE bearing			6318.2RS							
Weight of wound stator assembly	kg		327							
Weight of wound rotor assembly	kg		211							
Weight of complete generator	kg		1040							
Maximun overspeed	rpm		2250							
Unbalanced magnetic pull at f.l.cl.F	kN/mm		5							
Cooling air requirement	m <sup>3</sup> /min		54				64,8			
Inertia Constant (H)	sec.		0,176				0,212			
Noise level at 1m/7m	dB(A)		94 / 82				98 / 88			

All technical data are to be considered as a reference and they can be modified without any notice.

This document is a propriety of Mecc Alte S.p.A.. All rights reserved.

**50 Hz**

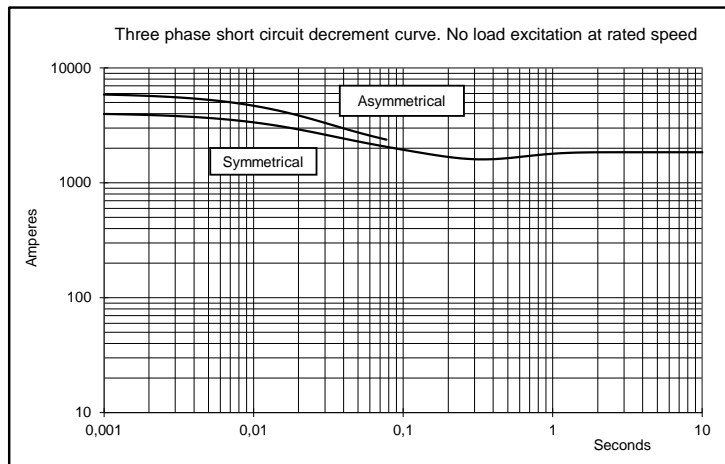
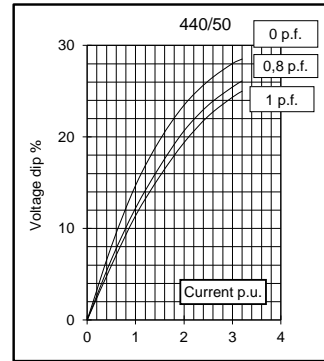
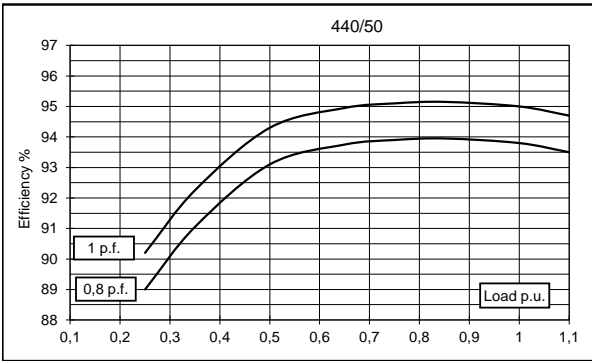
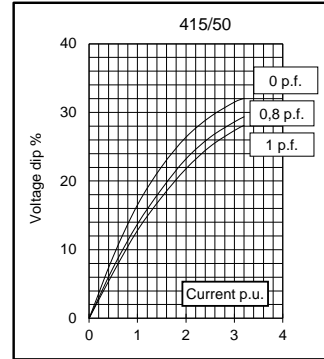
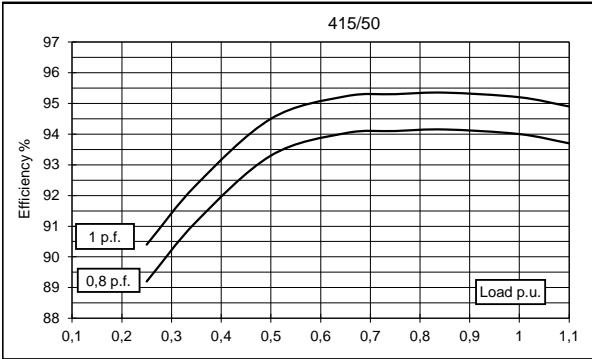
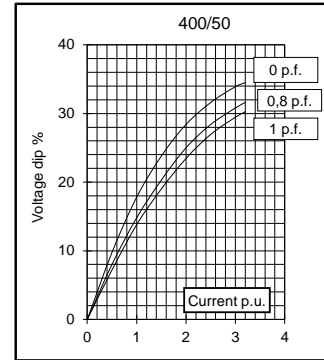
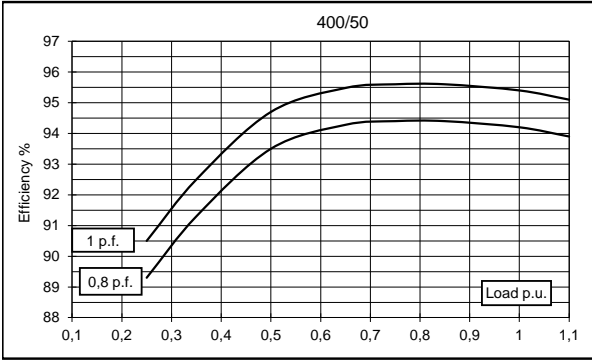
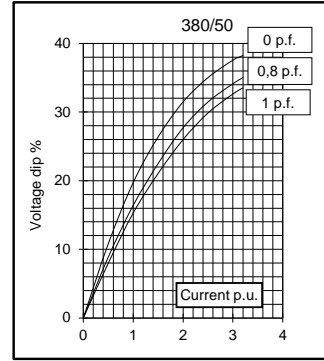
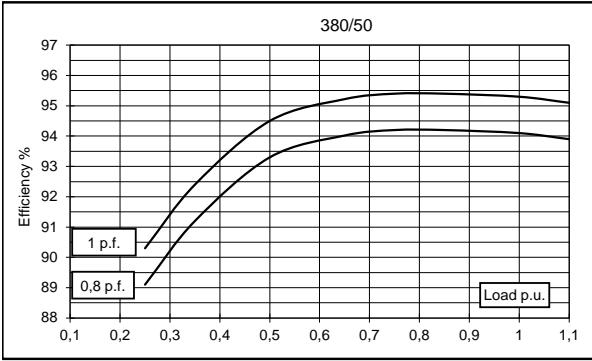

**60 Hz**

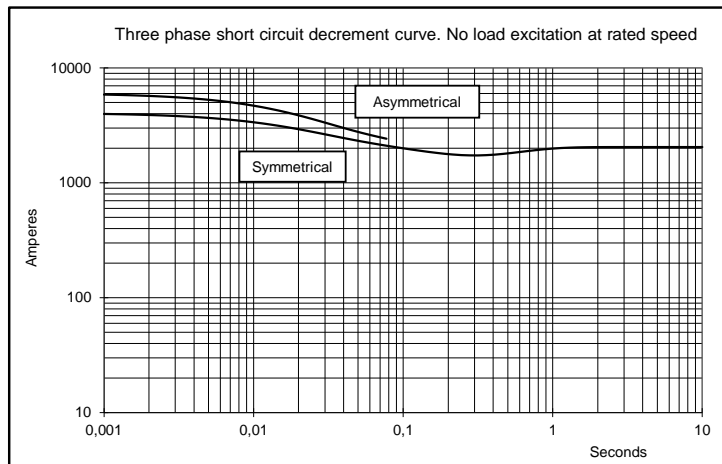
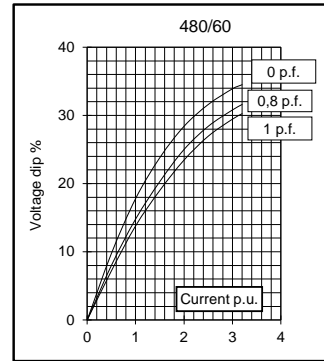
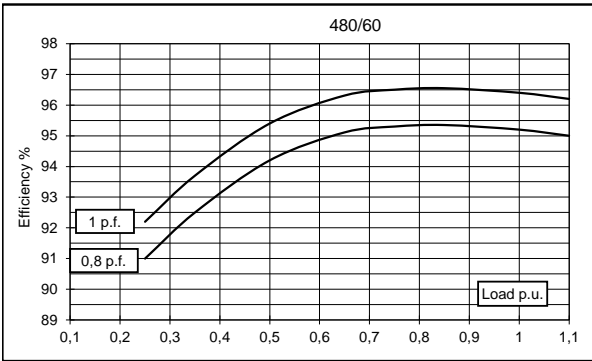
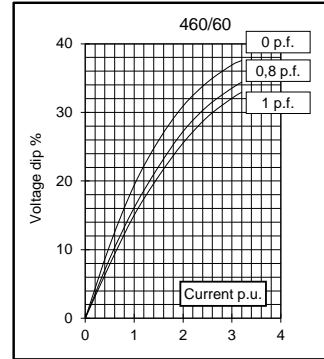
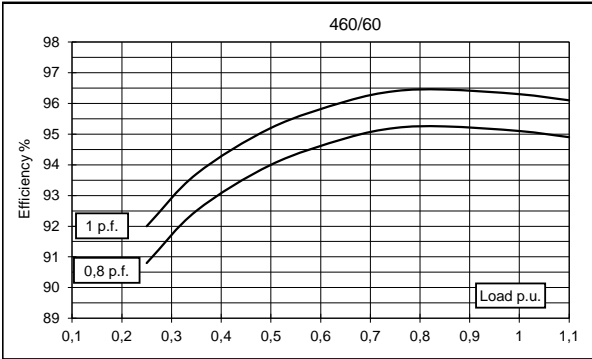
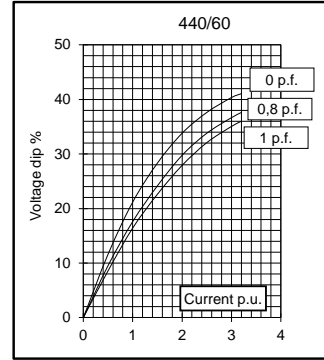
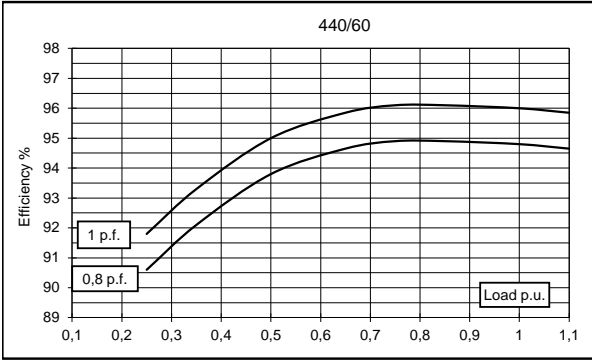
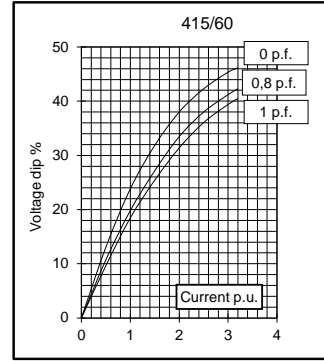
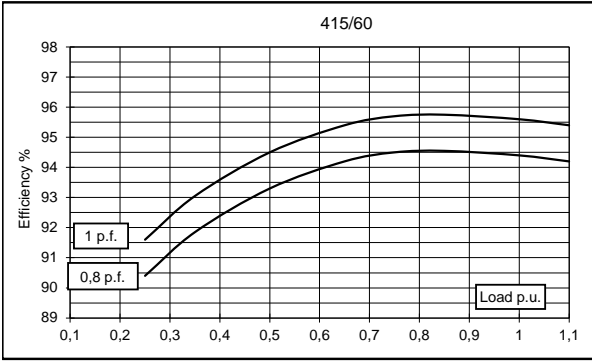

### TWO BEARING MOMENTS OF INERTIA

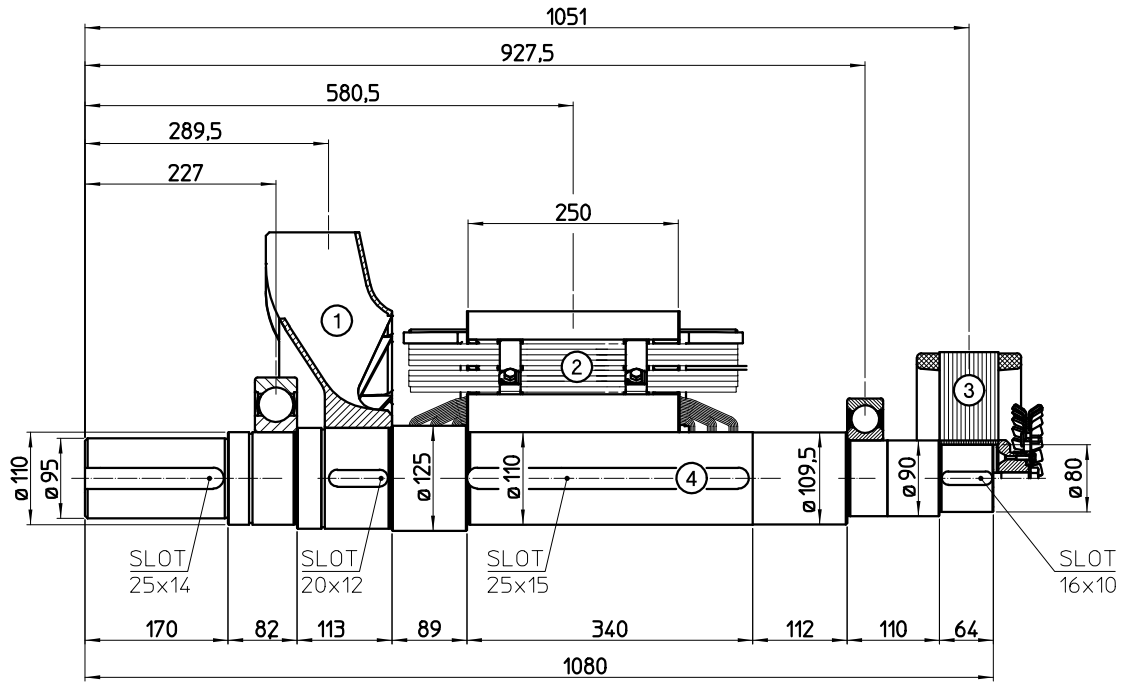

COMPONENT	WEIGHT kg	J kgm <sup>2</sup>
1 FAN	10,2	0,335
2 MAIN ROTOR	211	4,498
3 EX. ROTOR	35	0,562
4 SHAFT	73,6	0,109
TOTAL	329,8	5,504

### TWO BEARING DIMENSIONS

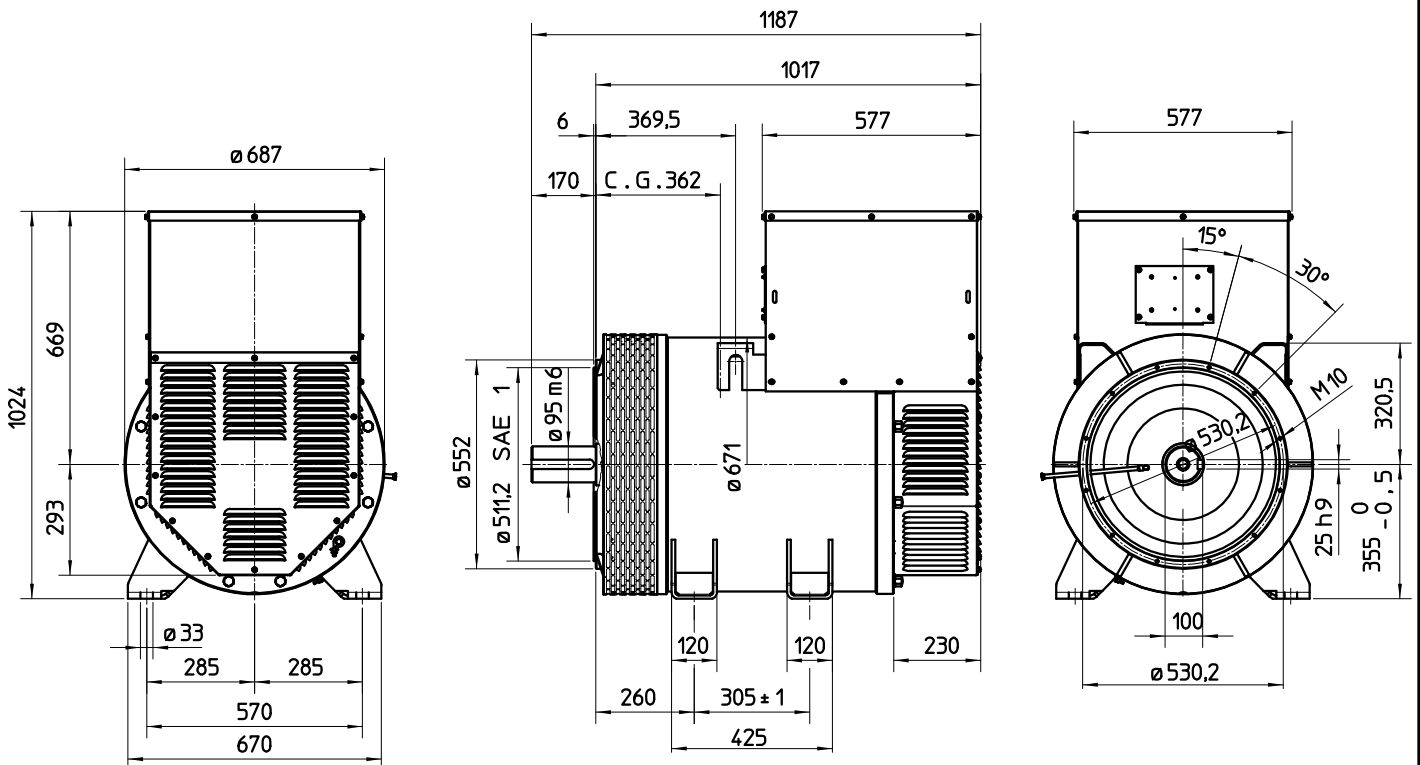

C.G.= GRAVITY CENTER

