



GENERATOR TYPE ECO 3-3LN/4

Document : DS102A/1

issue 001 date 27/09/2007

Electrical Characteristics										
Frequency	Hz	50				60				
Voltage (star)	V	380	400	415	440	415	440	460	480	
Rated power class H	kVA	15	15	15	12	16	18	18	18	
	kW	12	12	12	9,6	12,8	14,4	14,4	14,4	
Rated power class F	kVA	14	14	14	10,5	13	15	16,5	16,5	
	kW	11,2	11,2	11,2	8,4	10,4	12	13,2	13,2	
Regulation with SR7/2		±1,5 % with any power factor and speed variations between -5% +30%								
Insulation class		H								
Execution		Brushless								
Stator winding		6 ends								
Rotor		without damping cage								
Efficiencies class H	4/4	%	86,2	86,3	86	85,8	87,5	88	88,1	88,2
(see graph. for details)	3/4	%	86,6	86,9	86,8	86,5	87,8	88	88,2	88,4
	2/4	%	85,3	85,4	85,4	85,1	86,1	86,2	86,3	86,4
	1/4	%	81,8	81,8	81,6	81,1	82,6	82,4	82,5	82,8
Reactances (f. l.cl. F)	Xd	%	155,1	140	130,1	92,6	166,5	166,6	152,4	140
	Xd'	%	15,73	14,2	13,19	9,39	16,89	16,90	15,46	14,2
	Xd''	%	10,86	9,8	9,10	6,48	11,65	11,66	10,67	9,8
	Xq	%	86,4	78	72,5	51,6	92,8	92,8	84,9	78
	Xq'	%	86,4	78	72,5	51,6	92,8	92,8	84,9	78
	Xq''	%	57,6	52	48,3	34,4	61,8	61,9	56,6	52
	X ₂	%	18,95	17,1	15,89	11,31	20,33	20,35	18,62	17,1
	X ₀	%	5,98	5,4	5,02	3,57	6,42	6,43	5,88	5,4
Short Circuit Ratio	Kcc		0,80	1,1	1,13	1,50	0,67	0,75	0,80	1,1
Time Constants	Td'	sec.	0,042							
	Td''	sec.	0,0105							
	Tdo'	sec.	0,84							
	Tα	sec.	0,0112							
Short Circuit Current Capacity		%	>300				>320			
Excitation at no load	Amp.		0,3	0,35	0,4	0,47	0,22	0,25	0,3	0,32
Excitation at full load	Amp.		1,1	1,2	1,3	1,4	0,95	1	1,1	1,15
Overload (long-term)		%	1 hour in a 6 hours period 110% rated load							
Overload per 20 sec.		%	300							
Stator Winding Resistance (20°C)	Ω		0,628							
Rotor Winding Resistance (20°C)	Ω		10,884							
Exciter Resistance (20 °C)	Ω		Rotor : 1,453				Stator : 15,71			
Heat dissipation at f.l.cl.H	W		1921	1905	1953	1589	1829	1964	1945	1927
Telephone Interference			THF < 2%				TIF < 45			
Radio interference			EN60034-1, VDE 0875K. For others standards apply to factory.							
Waveform Distors.(THD) at f. load	LL/LN %		2,2 / 2,0							
Waveform Distors.(THD) at no load	LL/LN %		2,8 / 2,7							
Mechanical characteristics										
Protection			IP 23 (other protection on request)							
DE bearing			6308-2RS							
NDE bearing			6305-2RS							
Weight of wound stator assembly	kg		29,5							
Weight of wound rotor assembly	kg		16							
Weight of complete generator	kg		96,0							
Maximun overspeed	rpm		2250							
Unbalanced magnetic pull at f.l.cl.F	kN/mm		3							
Cooling air requirement	m³/min		3				3,5			
Inertia Constant (H)	sec.		0,098				0,116			
Noise level at 1m/7m	dB(A)		72 / 58				78 / 60			

All technical data are to be considered as a reference and they can be modified without any notice

This document is a propriety of Mecc Alte S.p.a..All rights reserved.

50 Hz

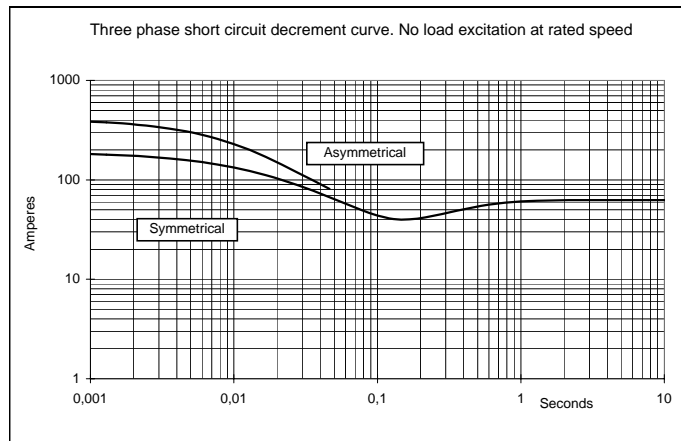
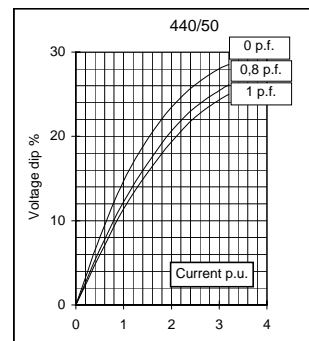
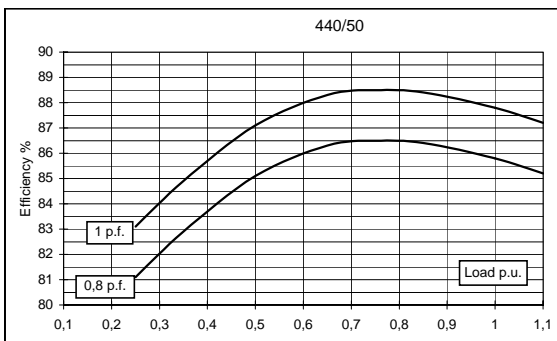
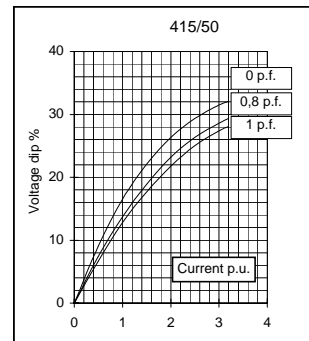
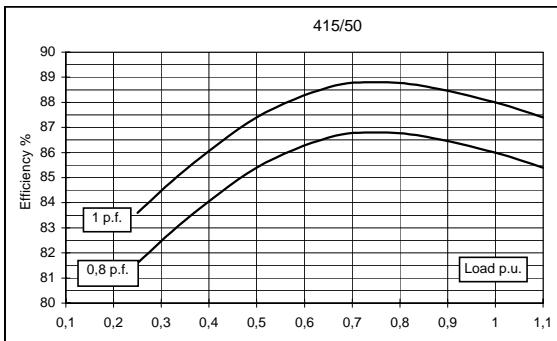
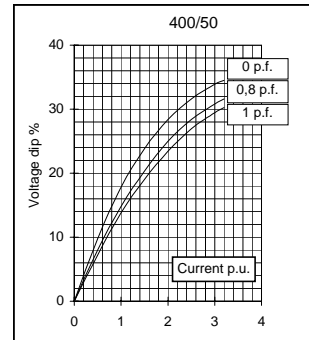
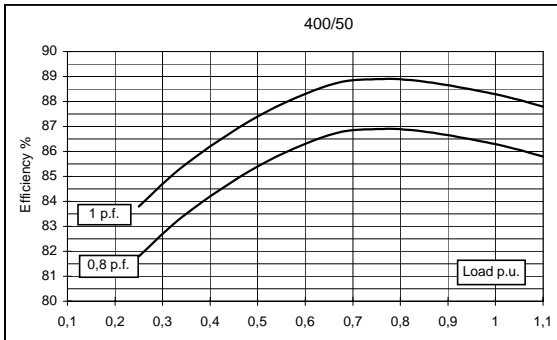
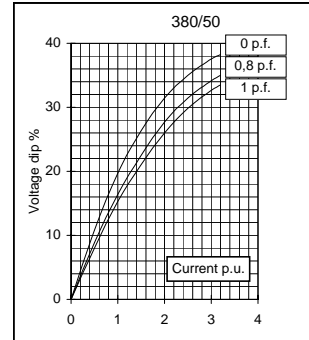
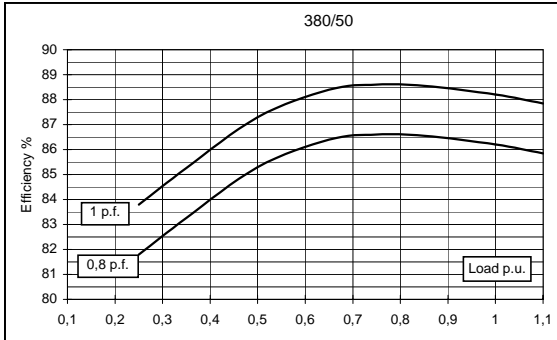

60 Hz

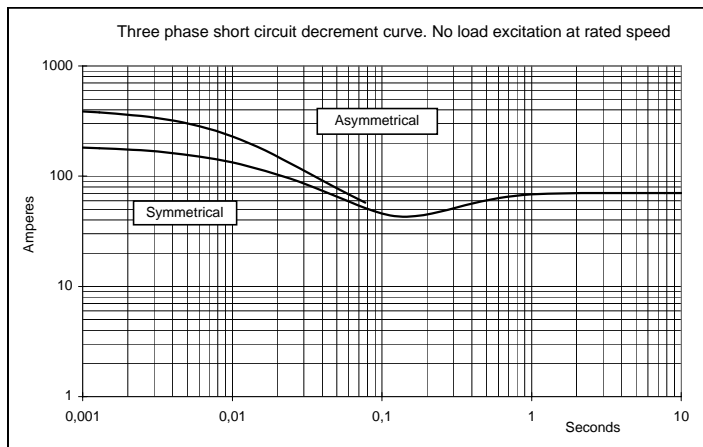
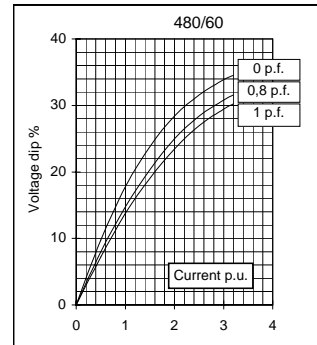
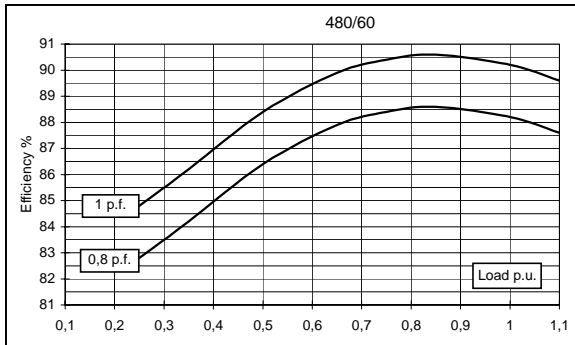
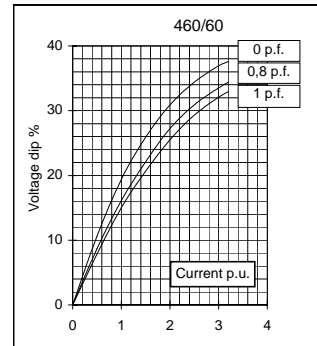
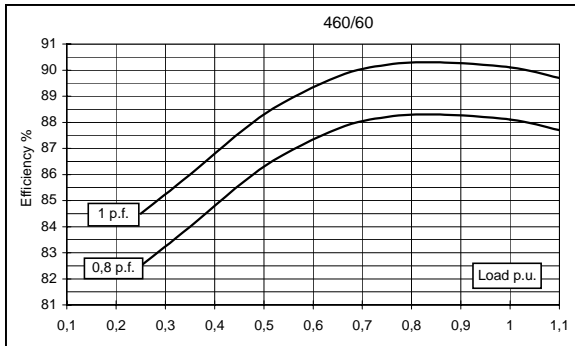
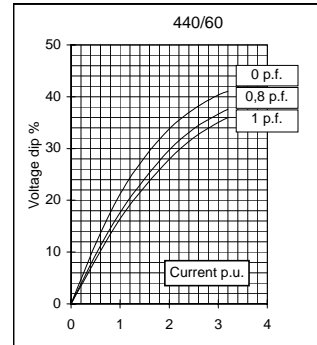
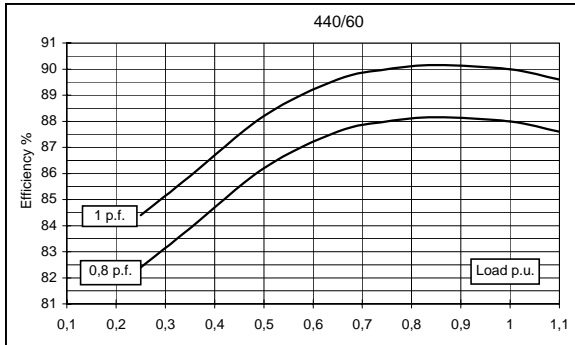
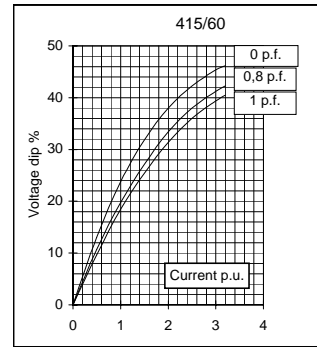
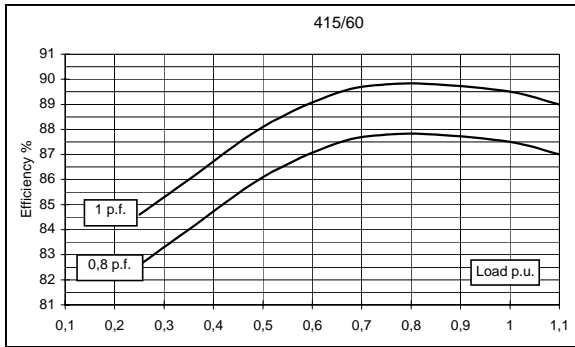

All technical data are to be considered as a reference and they can be modified without any notice
 This document is a propriety of Mecc Alte S.p.a.. All rights reserved.

TWO BEARING MOMENTS OF INERTIA

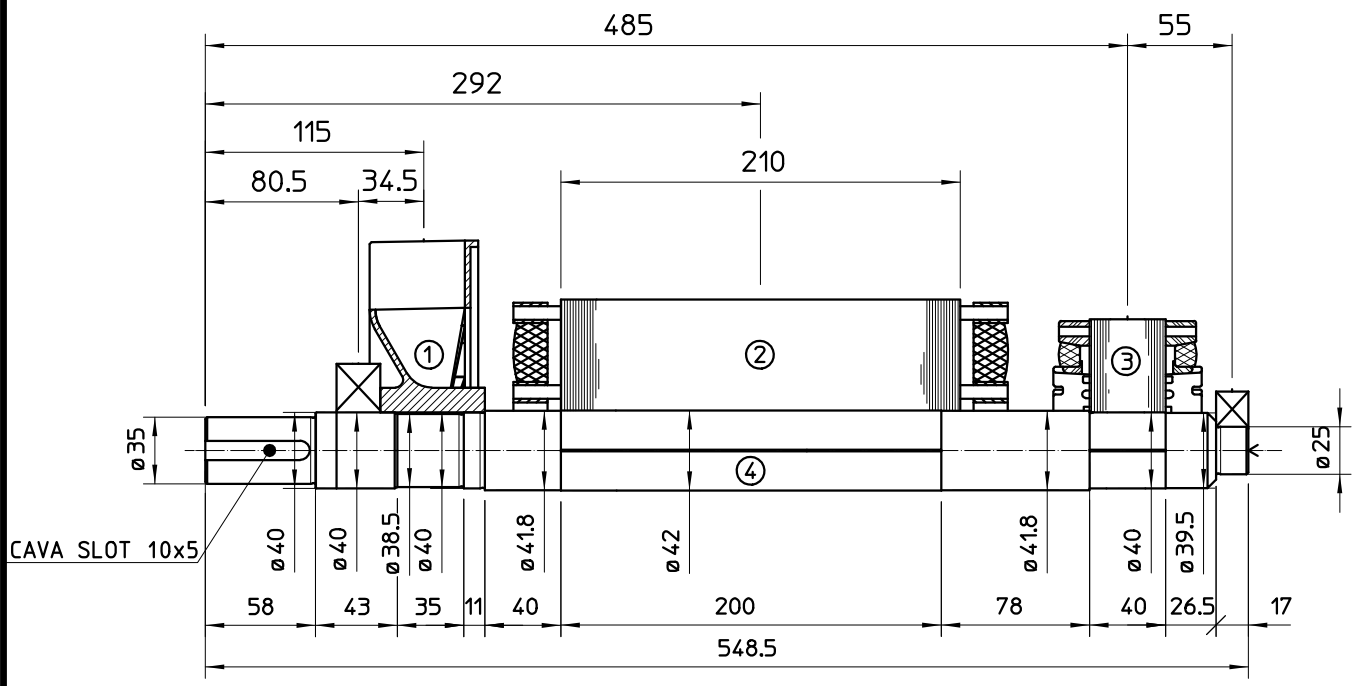

COMPONENT	WEIGHT Kg	J Kg ^m ²
1 FAN	0.93	0.0036
2 MAIN ROTOR	22.45	0.079
3 EX ROTOR	4.12	0.011
4 SHAFT	5.5	0.0011
6 TOTAL	33	0.0947

TWO BEARING DIMENSIONS

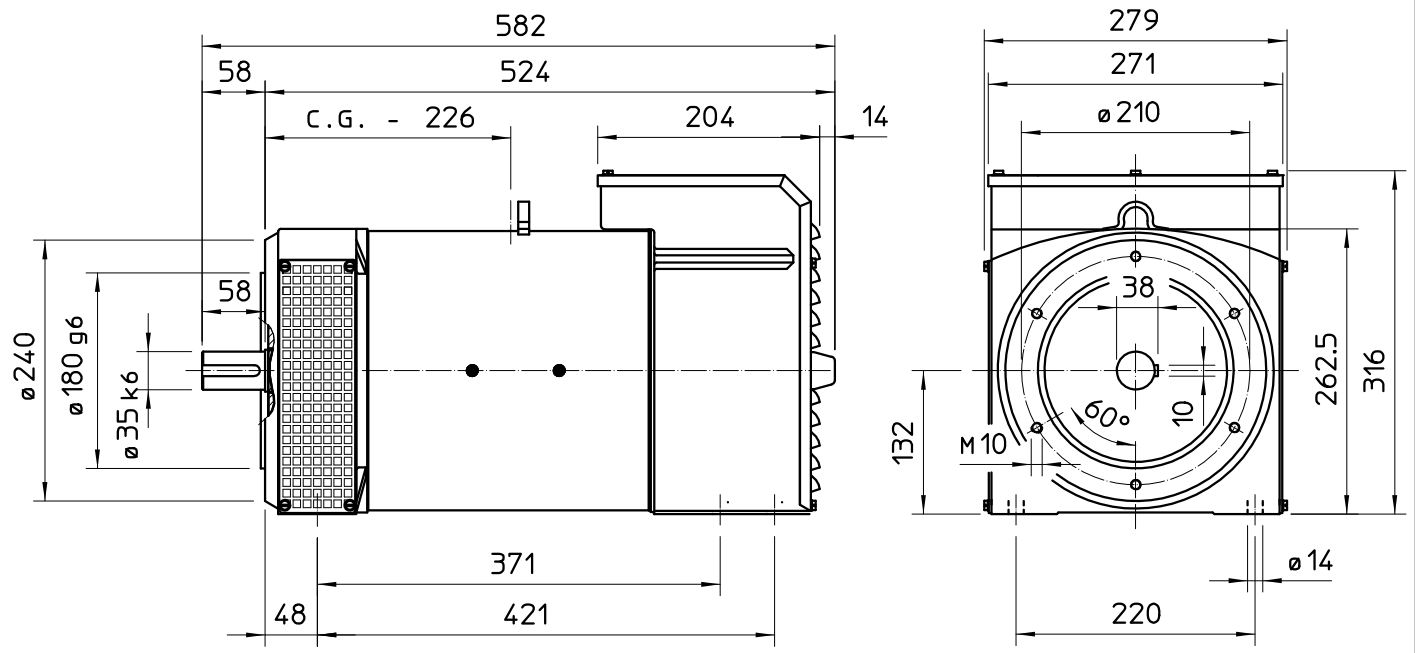

C.G. = GRAVITY CENTER

SINGLE BEARING MOMENTS OF INERTIA

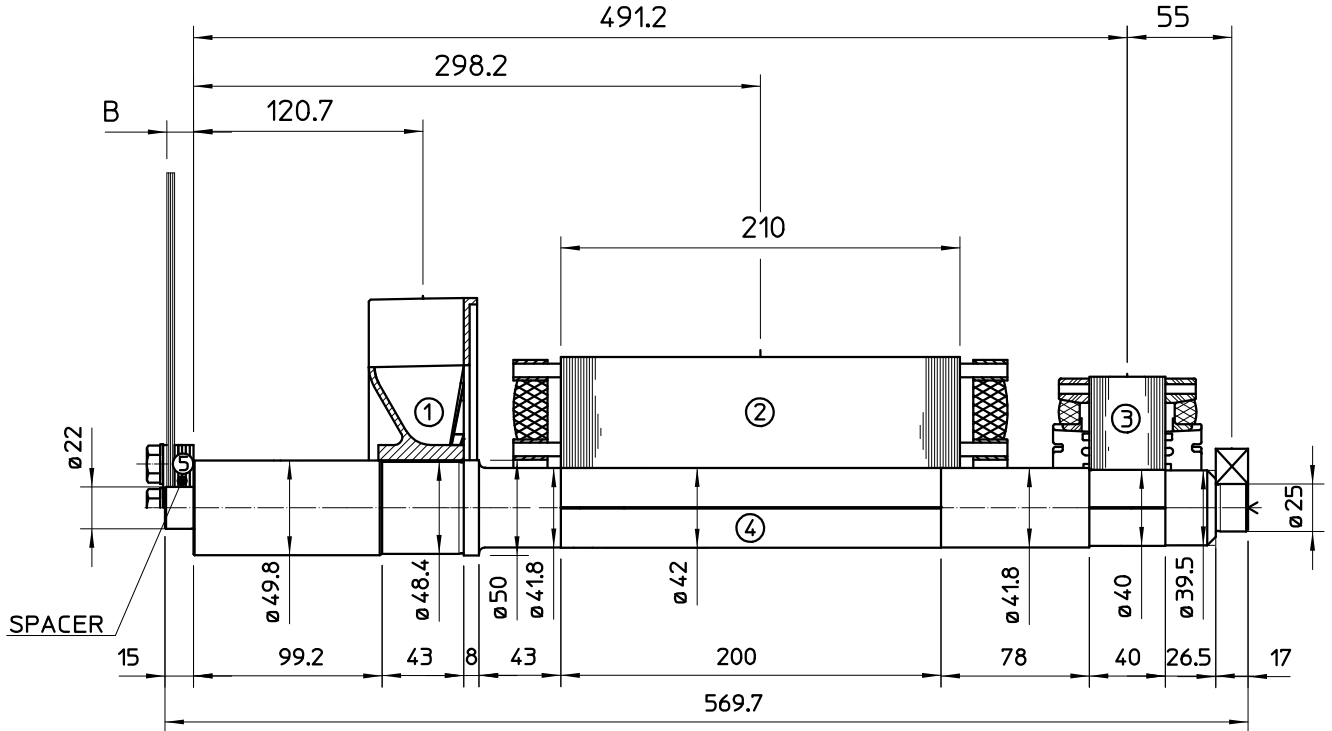

COMPONENT	WEIGHT Kg	J Kg ^m ²
1 FAN	0.82	0.0032
2 MAIN ROTOR	22.45	0.079
3 EX ROTOR	4.12	0.011
4 SHAFT	6.3	0.0013
TOTAL	33.69	0.0945

SAE N.	SHAFT COUPLING FLEX PLATE		
	B (mm)	WEIGHT kg	J kgm ²
6 1/2	4	1.14	0.0067
7 1/2	4	1.42	0.0103
8	35.6	1.97	0.0171
10	27.6	2.59	0.0319
11 1/2	14	3.1	0.0481

SINGLE BEARING DIMENSIONS

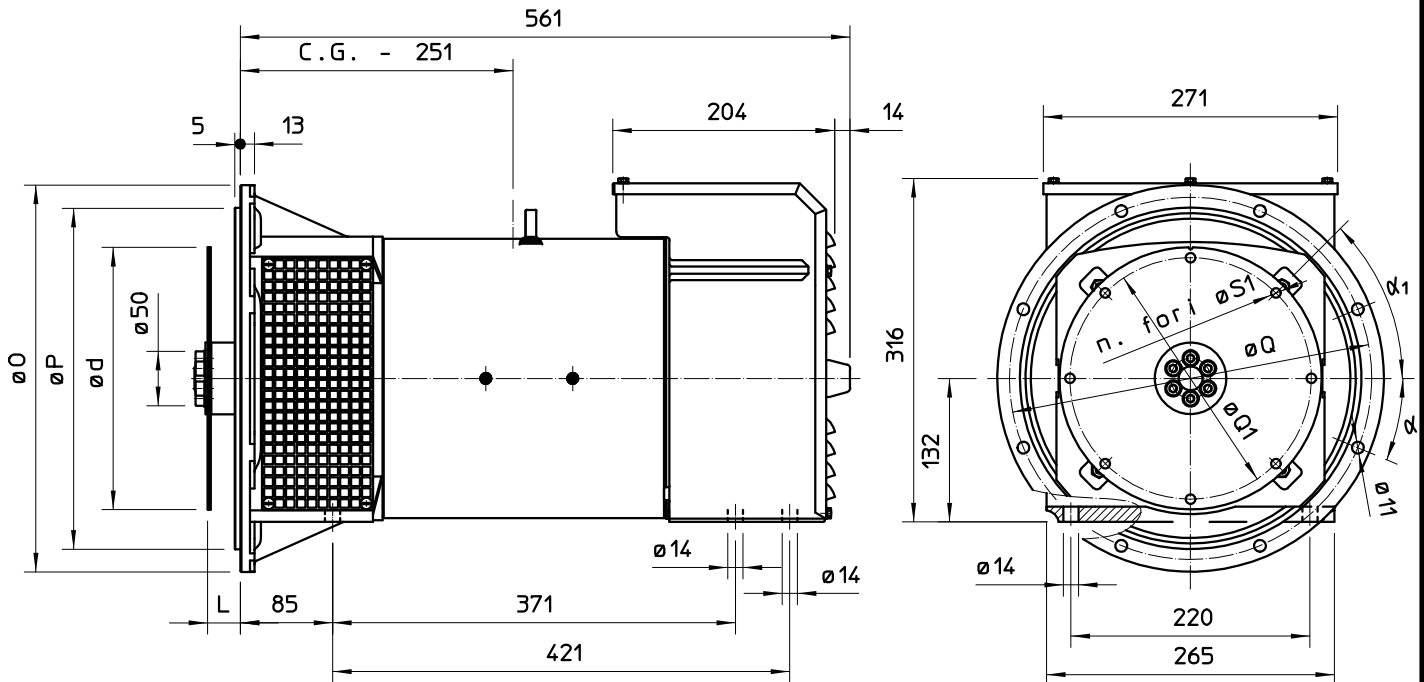

GIUNTI A DISCO COUPLING DISC PLATEX
DISQUE DE MONOPALIER SCHEIBENKUPPLUNG
JUNTAS A DISCOS

FLANGIA FLANGE BRIDE FLANSCH BRIDAS	SAE N.	O	P	Q	n. for i	α
	6	308	266.7	285.75	8	22°30'
	5	356	314.3	333.4	8	22°30'
	4	403	362	381	12	15°
	3	451	409.6	428.6	12	15°

SAE N.	L	d	Q1	n. for i	S1	α1
6 1/2	30.2	215.9	200	6	9	60°
7 1/2	30.2	241.3	222.25	8	9	45°
8	62	263.52	244.47	6	11	60°
10	53.8	314.32	295.27	8	11	45°
11 1/2	39.6	352.42	333.37	8	11	45°

C.G. = GRAVITY CENTER