

Electrical Characteristics										
Frequency	Hz	50				60				
Voltage (star)	V	380	400	415	440	415	440	460	480	
Rated power class H	kVA	13,5	13,5	13,5	11	14	16,2	16,2	16,2	
	kW	10,8	10,8	10,8	8,8	11,2	13	13	13	
Rated power class F	kVA	12,5	12,5	12,5	10	11,5	13,5	15	15	
	kW	10	10	10	8	9,2	10,8	12	12	
Regulation with	SR7/2	±1,5 % with any power factor and speed variations between -5% +30%								
Insulation class		H								
Execution		Brushless								
Stator winding		6 ends								
Rotor		without damping cage								
Efficiencies class H (see graph. for details)	4/4	%	86	86,1	85,8	85,6	87,2	87,7	87,8	87,9
	3/4	%	86,4	86,7	86,6	86,3	87,4	87,6	87,8	88
	2/4	%	85	85,1	85,1	84,8	85,8	85,9	86	86,1
	1/4	%	82	82	81,8	81,3	82,8	82,6	82,7	83
Reactances (f. l.cl. F)	Xd	%	153,8	138,8	128,9	93,5	160,5	165,2	151,1	138,8
	Xd'	%	15,40	13,9	12,91	9,36	16,07	16,54	15,13	13,9
	Xd''	%	10,86	9,8	9,10	6,60	11,33	11,66	10,67	9,8
	Xq	%	76,8	69,3	64,4	46,7	80,1	82,5	75,5	69,3
	Xq'	%	76,8	69,3	64,4	46,7	80,1	82,5	75,5	69,3
	Xq''	%	57,2	51,6	47,9	34,7	59,7	61,4	56,2	51,6
	X ₂	%	18,39	16,6	15,42	11,18	19,19	19,76	18,07	16,6
	X ₀	%	6,09	5,5	5,11	3,70	6,36	6,55	5,99	5,5
Short Circuit Ratio	Kcc		0,80	0,98	1,13	1,50	0,67	0,75	0,80	0,98
Time Constants	Td'	sec.	0,044							
	Td''	sec.	0,009							
	Tdo'	sec.	0,84							
	Tα	sec.	0,011							
Short Circuit Current Capacity	%	>300				>320				
Excitation at no load	Amp.	0,3	0,35	0,4	0,47	0,22	0,25	0,3	0,32	
Excitation at full load	Amp.	1,1	1,2	1,3	1,4	0,95	1	1,1	1,15	
Overload (long-term)	%	1 hour in a 6 hours period 110% rated load								
Overload per 20 sec.	%	300								
Stator Winding Resistance (20°C)	Ω	0,732								
Rotor Winding Resistance (20°C)	Ω	9,743								
Exciter Resistance (20 °C)	Ω	Rotor : 1,453				Stator : 15,71				
Heat dissipation at f.l.cl.H	W	1758	1744	1787	1480	1644	1818	1801	1784	
Telephone Interference		THF < 2%				TIF < 45				
Radio interference		EN60034-1, VDE 0875K. For others standards apply to factory.								
Waveform Distors.(THD) at f. load	LL/LN %	2,2 / 2,0								
Waveform Distors.(THD) at no load	LL/LN %	2,8 / 2,7								
Mechanical characteristics										
Protection		IP 23 (other protection on request)								
DE bearing		6308-2RS								
NDE bearing		6305-2RS								
Weight of wound stator assembly	kg	26,7								
Weight of wound rotor assembly	kg	14,5								
Weight of complete generator	kg	91,5								
Maximun overspeed	rpm	2250								
Unbalanced magnetic pull at f.l.cl.F	kN/mm	3								
Cooling air requirement	m³/min	3				3,5				
Inertia Constant (H)	sec.	0,085				0,102				
Noise level at 1m/7m	dB(A)	72 / 58				78 / 60				

50 Hz

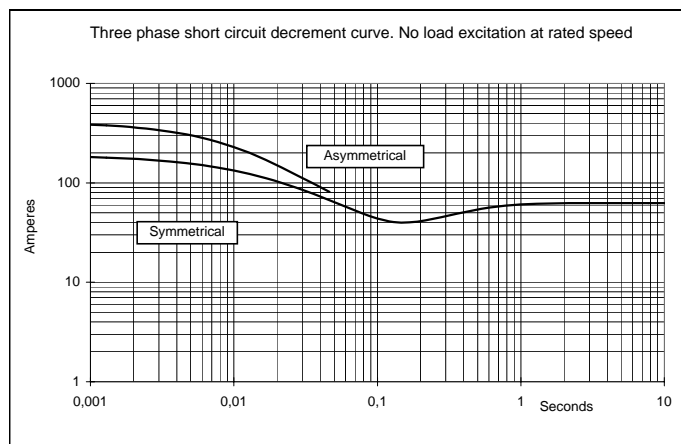

60 Hz

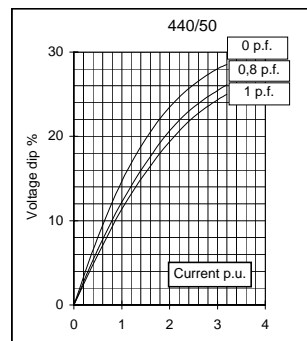
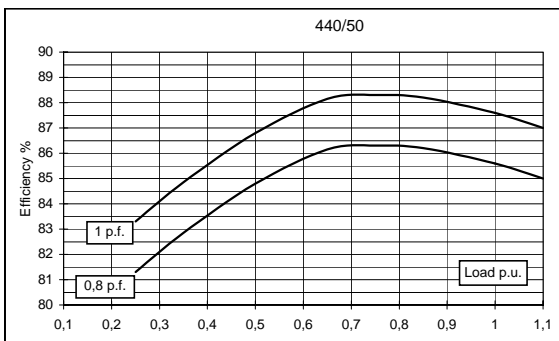
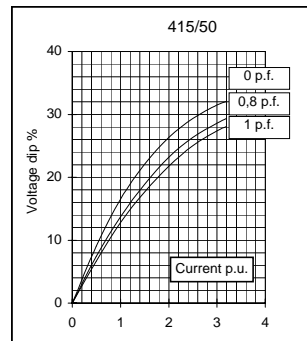
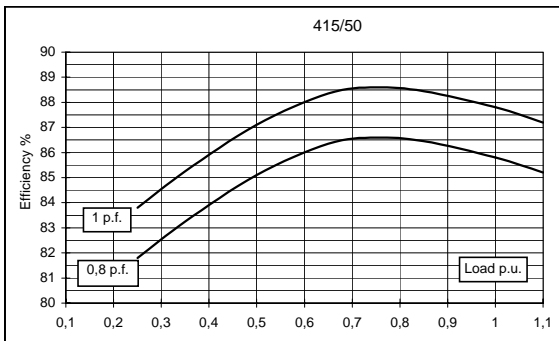
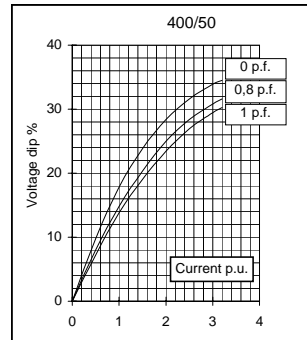
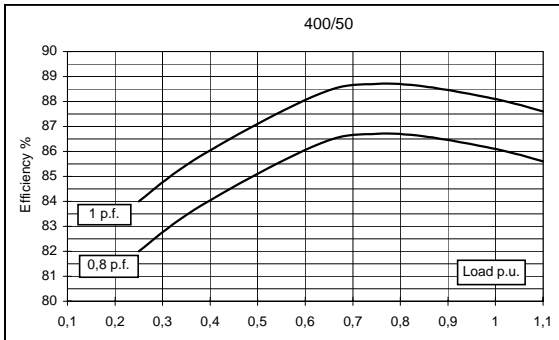
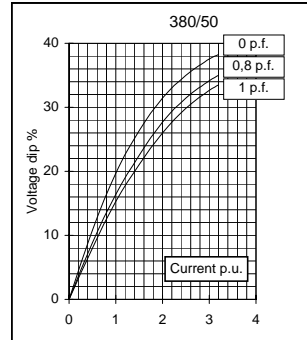
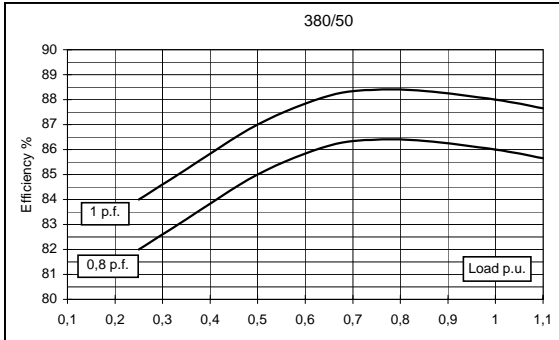
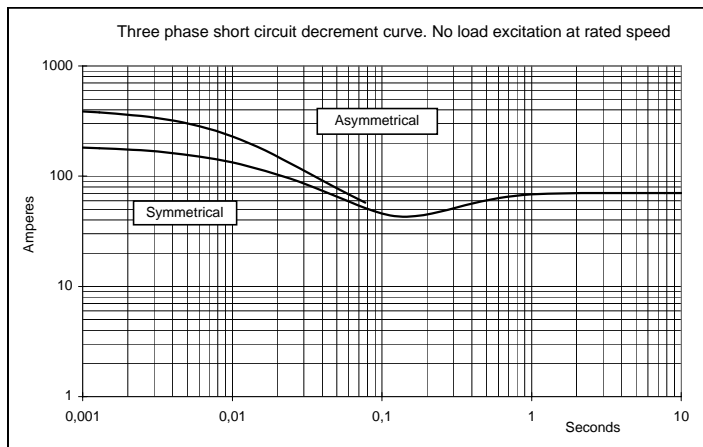
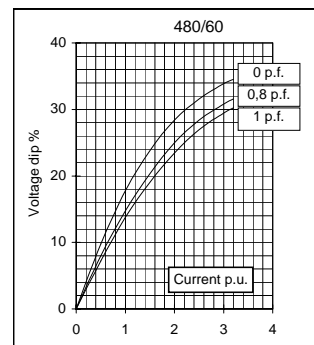
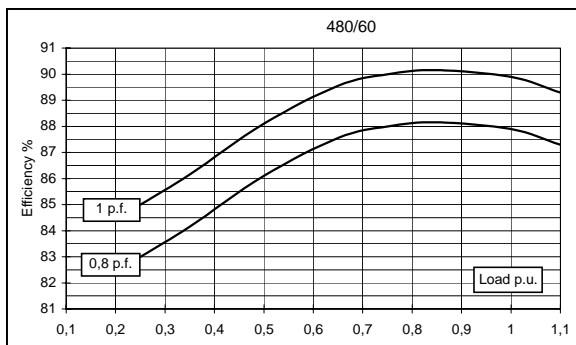
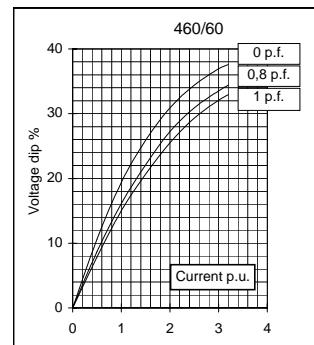
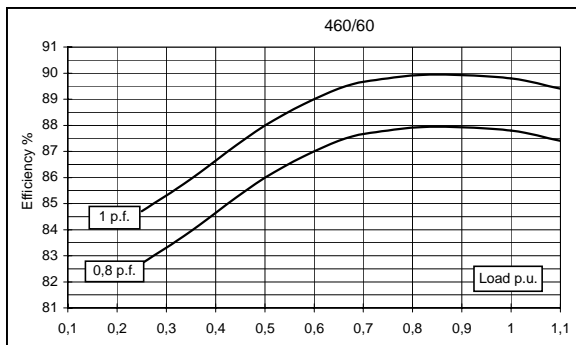
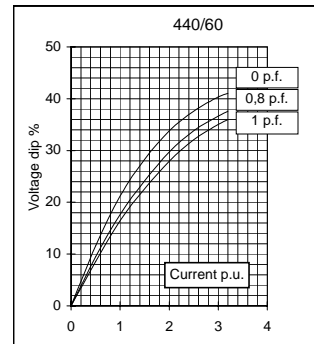
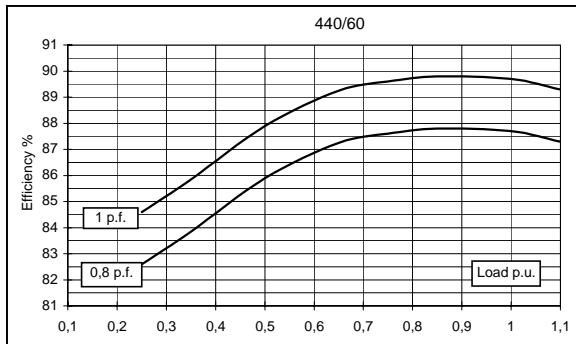
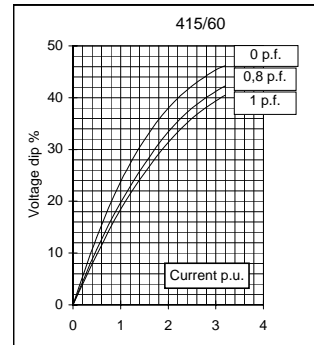
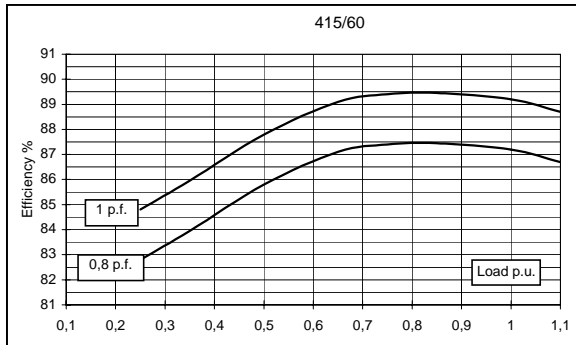

TWO BEARING MOMENTS OF INERTIA

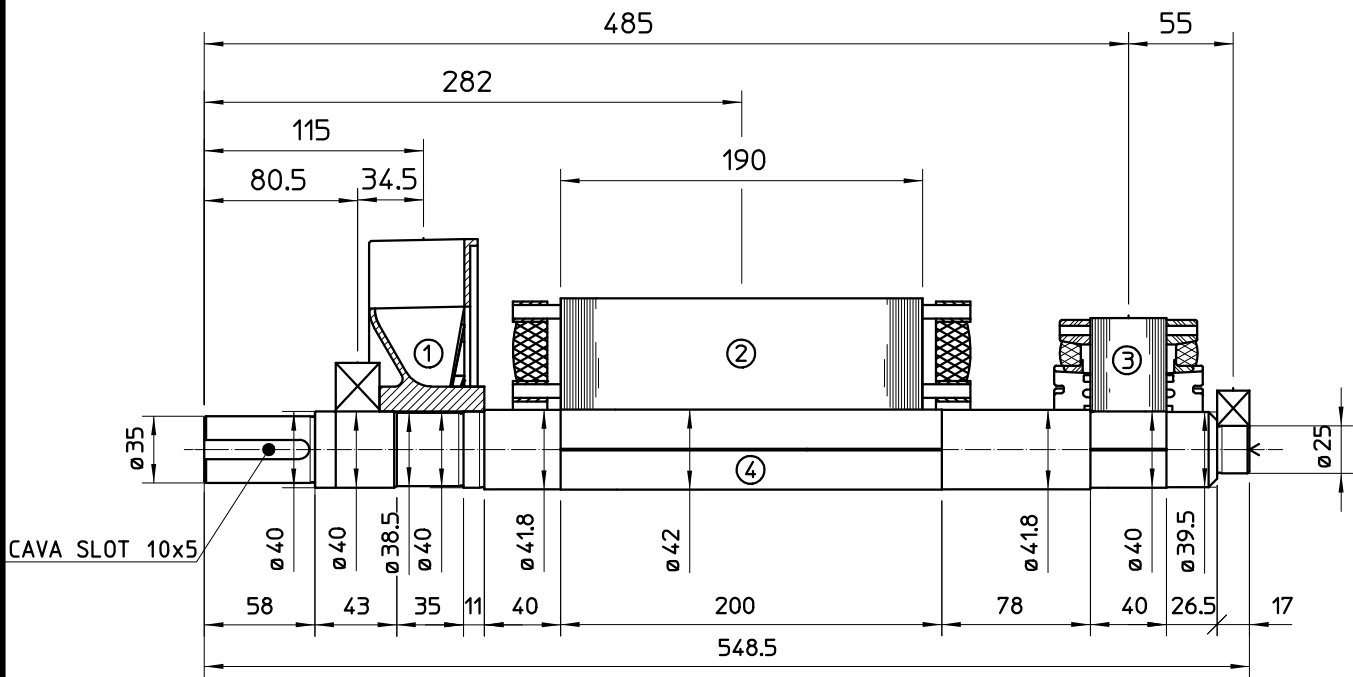

COMPONENT	WEIGHT Kg	J Kg ²
1 FAN	0.93	0.0036
2 MAIN ROTOR	20.55	0.075
3 EX ROTOR	4.12	0.011
4 SHAFT	5.5	0.0011
6 TOTAL	31.1	0.0907

TWO BEARING DIMENSIONS

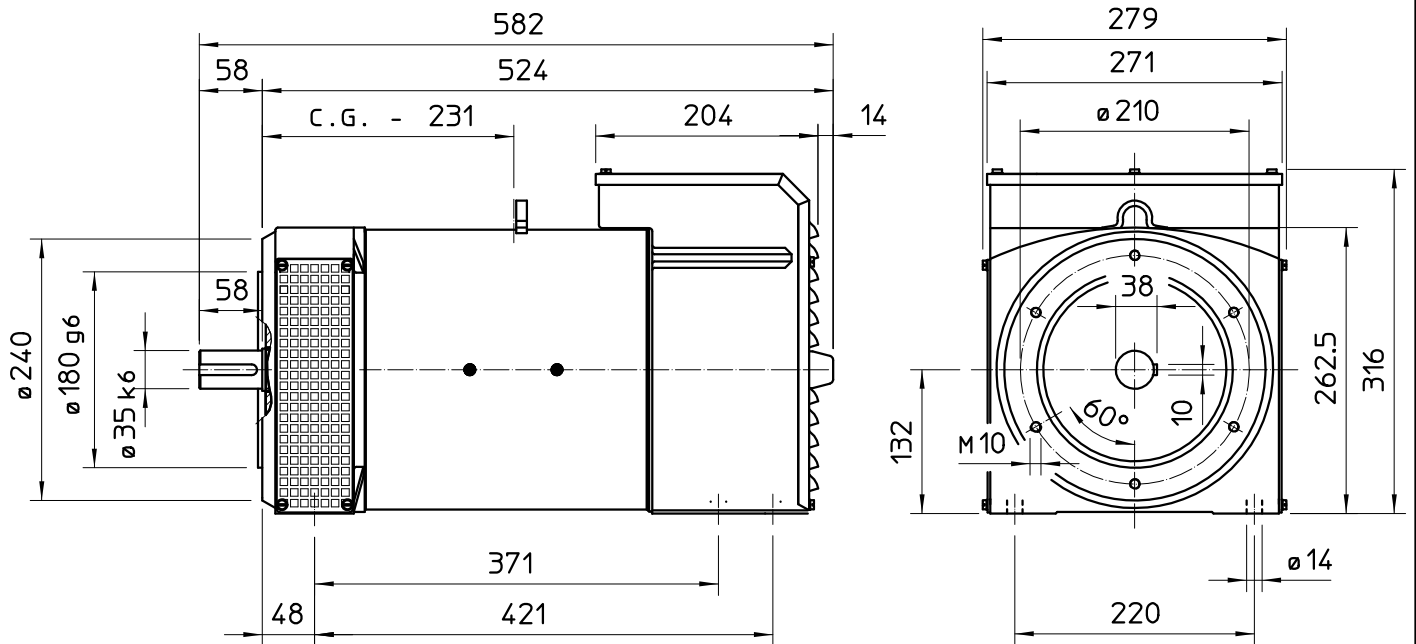

SINGLE BEARING MOMENTS OF INERTIA

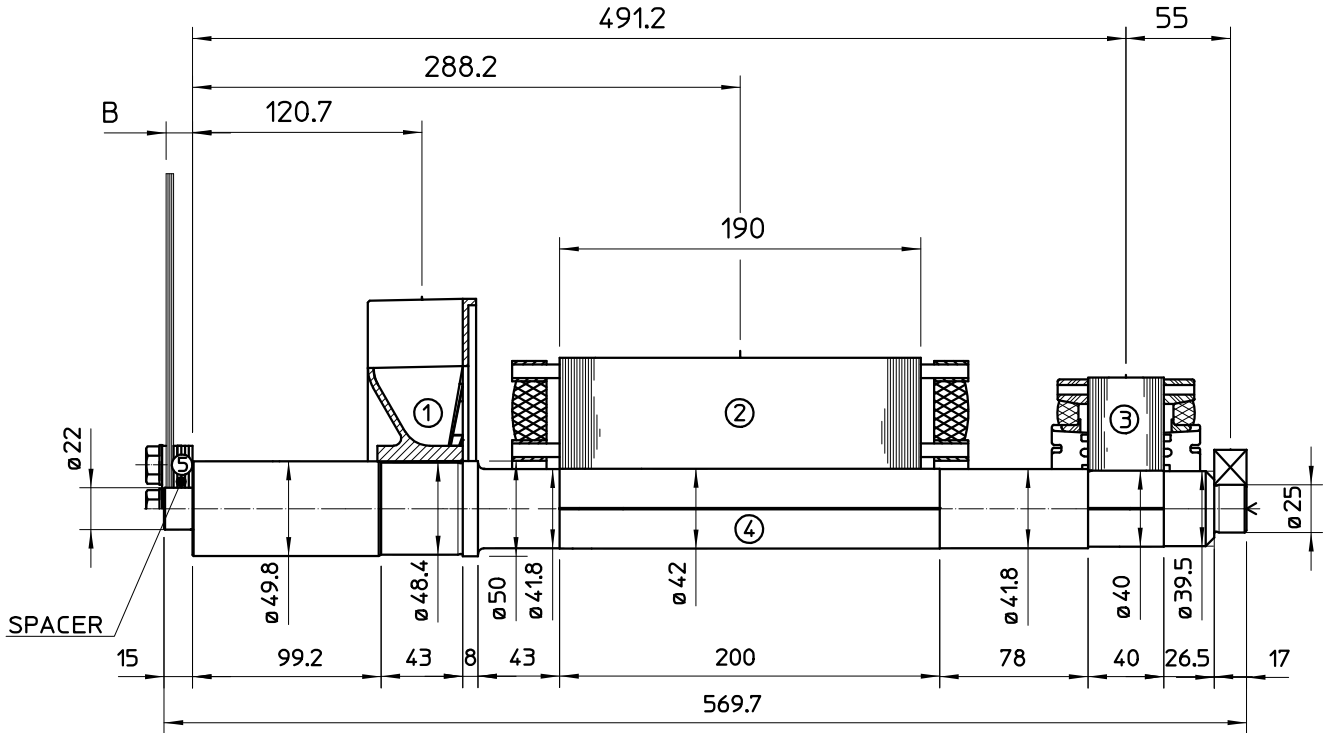

COMPONENT	WEIGHT Kg	J Kg ²
1 FAN	0.82	0.0032
2 MAIN ROTOR	20.55	0.075
3 EX ROTOR	4.12	0.011
4 SHAFT	6.3	0.0013
6 TOTAL	31.79	0.0905

SAE N.	5	SHAFT COUPLING FLEX PLATE	
	B (mm)	WEIGHT kg	J kgm ²
6 1/2	4	1.14	0.0067
7 1/2	4	1.42	0.0103
8	35.6	1.97	0.0171
10	27.6	2.59	0.0319
11 1/2	14	3.1	0.0481

SINGLE BEARING DIMENSIONS

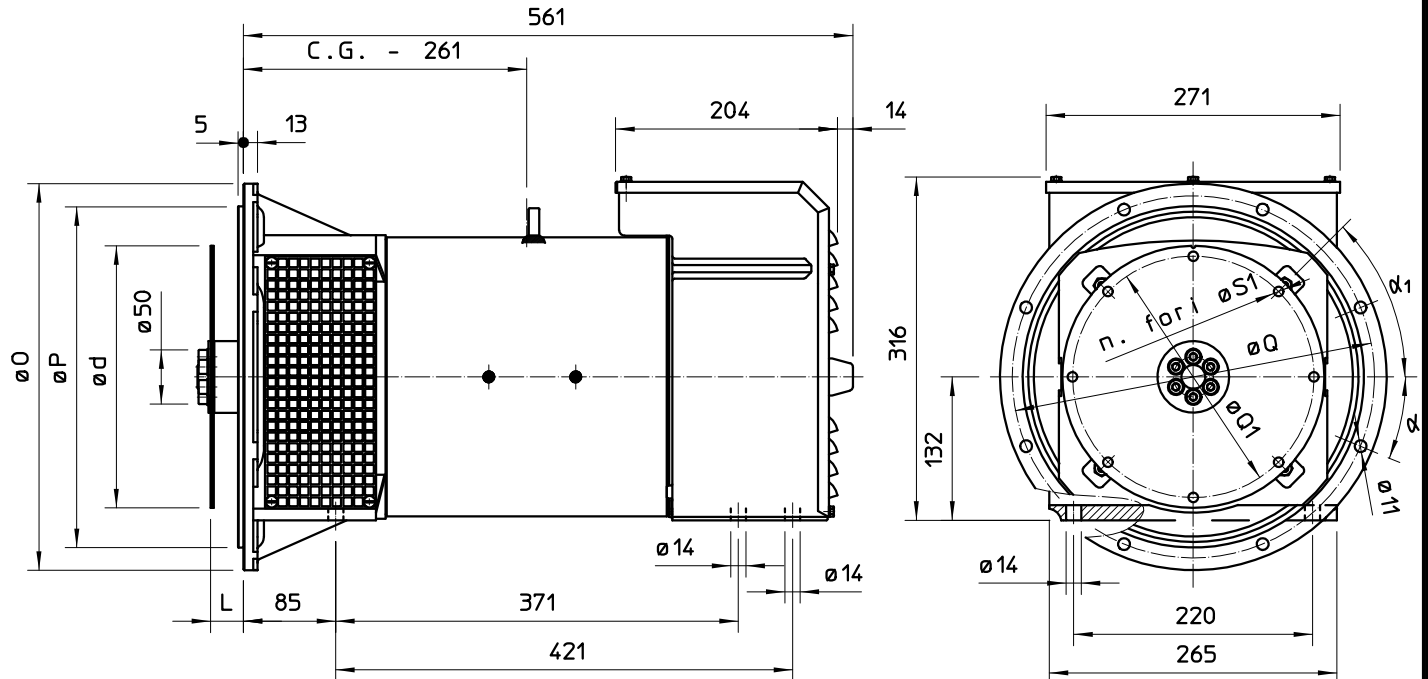

GIUNTI A DISCO COUPLING DISC PLATEX
DISQUE DE MONPALIER SCHEIBENKUPPLUNG
JUNTAS A DISCOS

FLANGIA FLANGE BRIDE FLANSCH BRIDAS	SAE N.	O	P	Q	n. fori	α
	6	308	266.7	285.75	8	22°30'
	5	356	314.3	333.4	8	22°30'
	4	403	362	381	12	15°
	3	451	409.6	428.6	12	15°

SAE N.	L	d	Q1	n. fori	S1	α
6 1/2	30.2	215.9	200	6	9	60°
7 1/2	30.2	241.3	222.25	8	9	45°
8	62	263.52	244.47	6	11	60°
10	53.8	314.32	295.27	8	11	45°
11 1/2	39.6	352.42	333.37	8	11	45°

C.G. = GRAVITY CENTER