



GENERATOR TYPE ECO 38-2LN/4

Document : DS074A/1

issue 005 date 28/10/2013

Electrical Characteristics										
Frequency	Hz	50				60				
Voltage (series star)	V	380	400	415	440	415	440	460	480	
Rated power class H	kVA	300	300	300	290	325	340	360	360	
	kW	240	240	240	232	260	272	288	288	
Rated power class F	kVA	275	275	275	265	300	310	330	330	
	kW	220	220	220	212	240	248	264	264	
Regulation with DSR		±1 % with any power factor and speed variations between -5% +30%								
Insulation class		H								
Execution		Brushless								
Stator winding		12 ends								
Rotor		with damping cage								
Efficiencies class H	4/4	%	93,5	93,7	93,4	93,2	94	94,5	94,6	94,7
(see graph. for details)	3/4	%	93,8	94	93,9	93,6	94,5	94,7	94,9	95,1
	2/4	%	92,7	92,7	92,7	92,5	93,6	93,7	93,8	93,9
	1/4	%	90,2	89,9	89,7	89,5	90,6	90,6	90,6	90,4
Reactances (f. l.cl. F)	Xd	%	230,5	208	193,2	166,2	251,2	233,8	226,5	208
	Xd'	%	17,0	15,3	14,2	12,2	18,5	17,2	16,7	15,3
	Xd''	%	9,0	8,1	7,5	6,5	9,8	9,1	8,8	8,1
	Xq	%	133,0	120	111,5	95,9	144,9	134,9	130,7	120
	Xq'	%	133,0	120	111,5	95,9	144,9	134,9	130,7	120
	Xq''	%	23,0	20,8	19,3	16,6	25,1	23,4	22,6	20,8
	X ₂	%	17,8	16,1	15,0	12,9	19,4	18,1	17,5	16,1
	X ₀	%	2,5	2,3	2,1	1,8	2,8	2,6	2,5	2,3
Short Circuit Ratio	Kcc		0,39	0,43	0,62	0,97	0,32	0,38	0,40	0,43
Time Constants	Td'	sec.	0,091							
	Td''	sec.	0,0125							
	Tdo'	sec.	1,40							
	Tα	sec.	0,016							
Short Circuit Current Capacity		%	>300				>350			
Excitation at no load	Amp.		0,65	0,78	0,95	1,2	0,4	0,5	0,6	0,7
Excitation at full load	Amp.		3,8	3,9	4	4,2	3,2	3,6	3,7	3,8
Overload (long-term)		%	1 hour in a 6 hours period 110% rated load							
Overload per 20 sec.		%	300							
Stator Winding Resistance (20 °C)		Ω	0,0055							
Rotor Winding Resistance (20 °C)		Ω	5,604							
Exciter Resistance (20 °C)		Ω	Rotor : 0,685				Stator : 15,28			
Heat dissipation at f.l.cl.H	W		16684	16137	16959	16927	16596	15831	16440	16118
Telephone Interference			THF < 2%				TIF < 40			
Radio interference			EN61000-6-3, EN61000-6-2. For others standards apply to factory							
Waveform Distors.(THD) at f. load	LL/LN %		3 / 2,9							
Waveform Distors.(THD) at no load	LL/LN %		2,6 / 2,8							
Mechanical characteristics										
Protection			IP 21 (other protection on request)							
DE bearing			6318.2RS							
NDE bearing			6314.2RS							
Weight of wound stator assembly	kg		258							
Weight of wound rotor assembly	kg		181							
Weight of complete generator	kg		765							
Maximun overspeed	rpm		2250							
Unbalanced magnetic pull at f.l.cl.F	kN/mm		5,9							
Cooling air requirement	m ³ /min		32				39			
Inertia Constant (H)	sec.		0,117				0,140			
Noise level at 1m/7m	dB(A)		82 / 69				86 / 73			

All technical data are to be considered as a reference and they can be modified without any notice

This document is a propriety of Mecc Alte S.p.a..All rights reserved.



GENERATOR TYPE ECO 38-2LN/4

Document : DS074A/2

issue 005 date : 28/10/2013

50 Hz

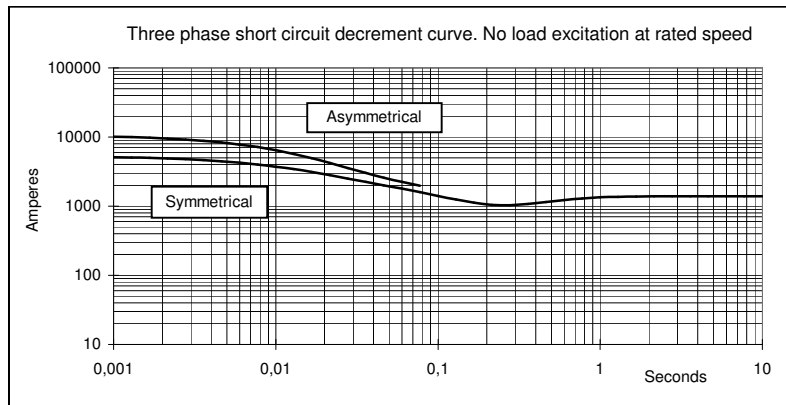
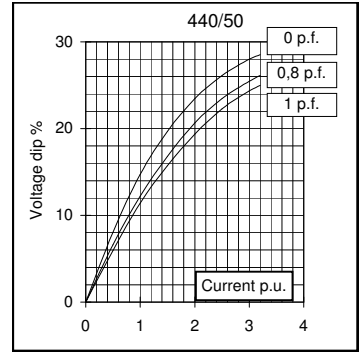
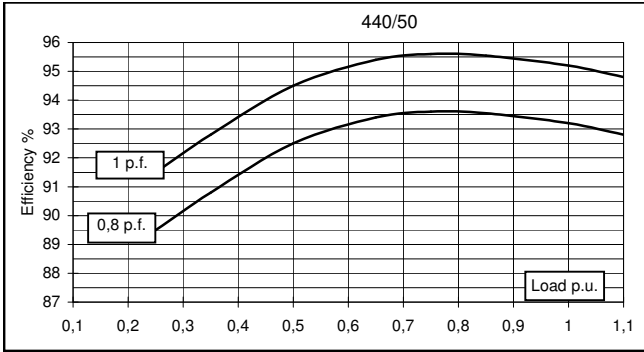
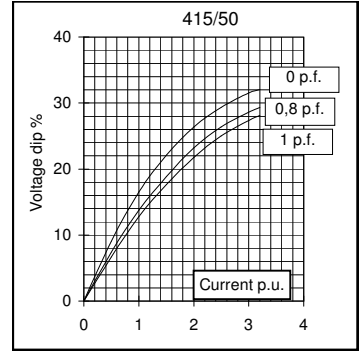
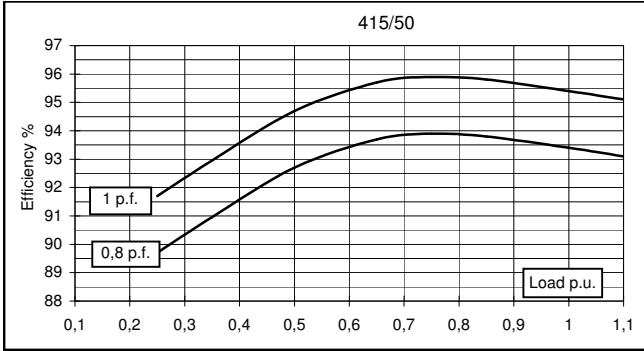
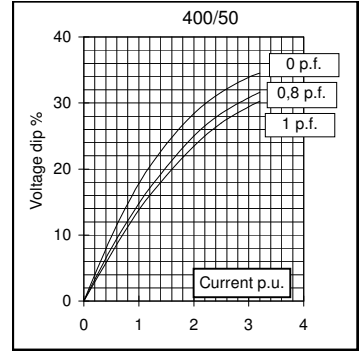
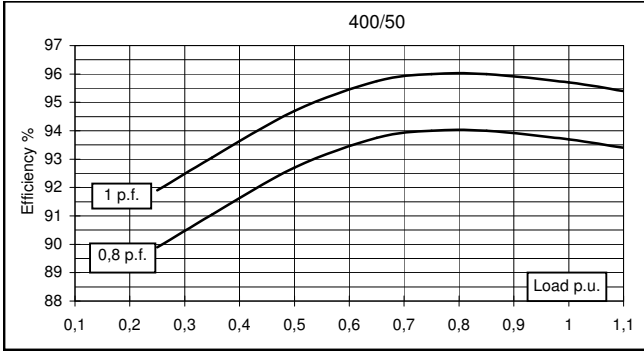
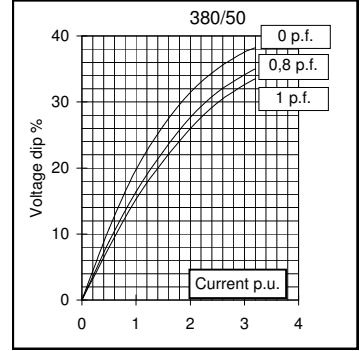
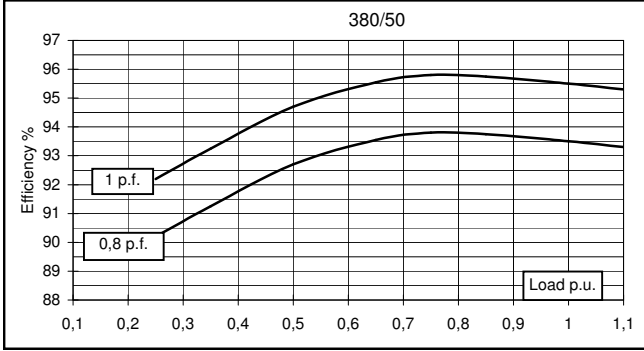

60 Hz

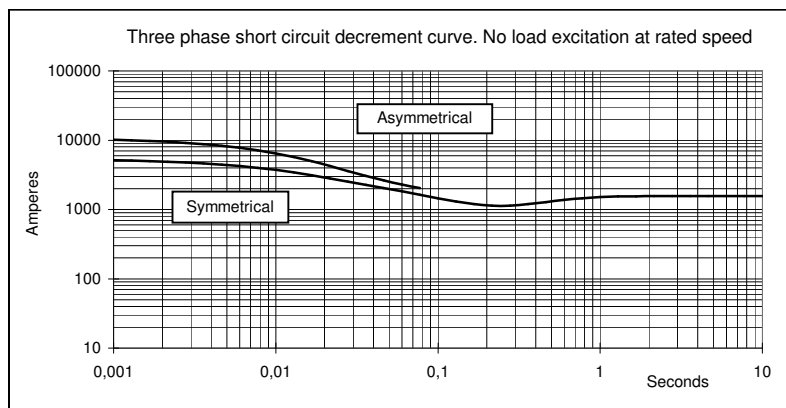
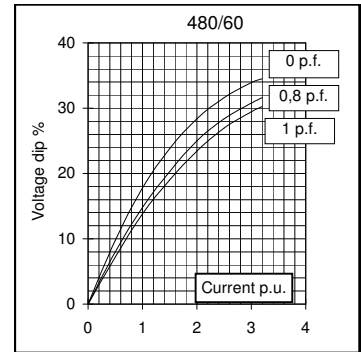
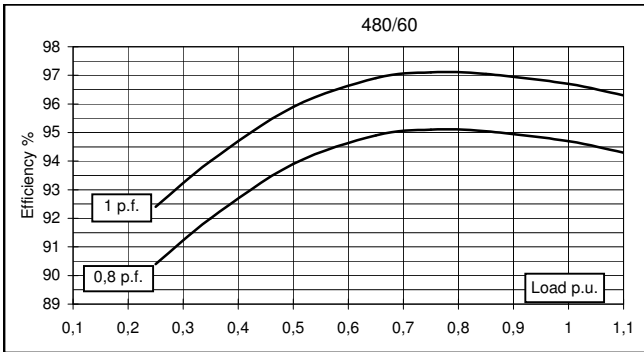
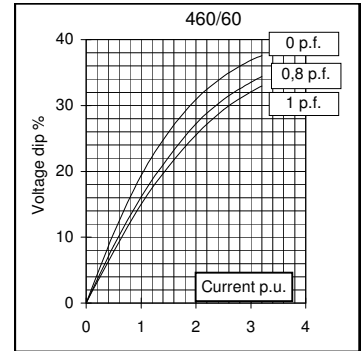
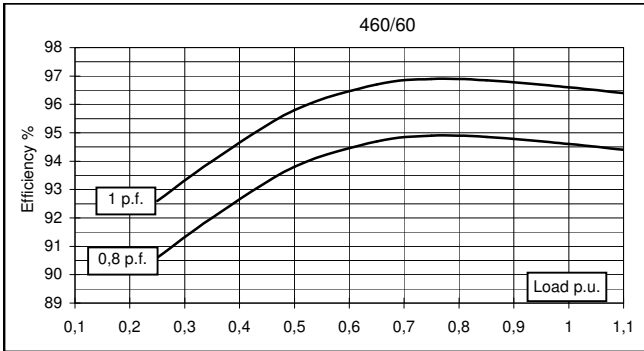
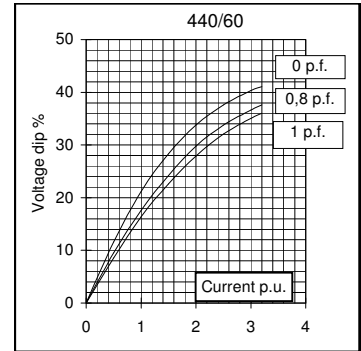
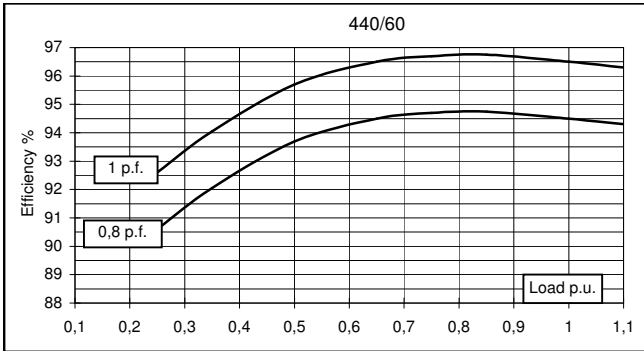
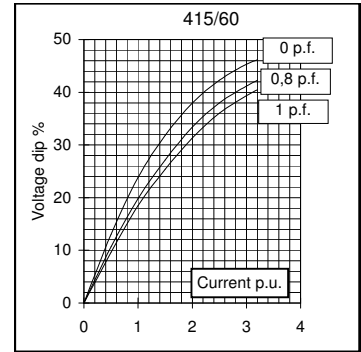
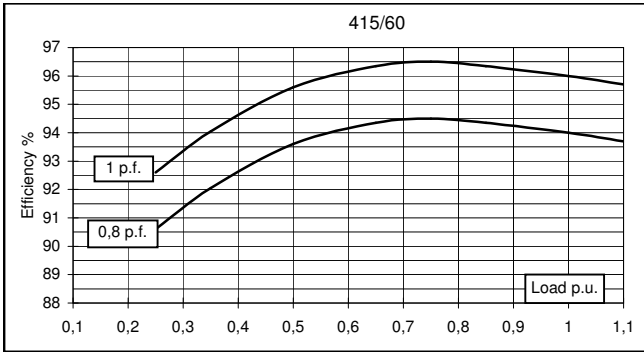

TWO BEARING MOMENTS OF INERTIA

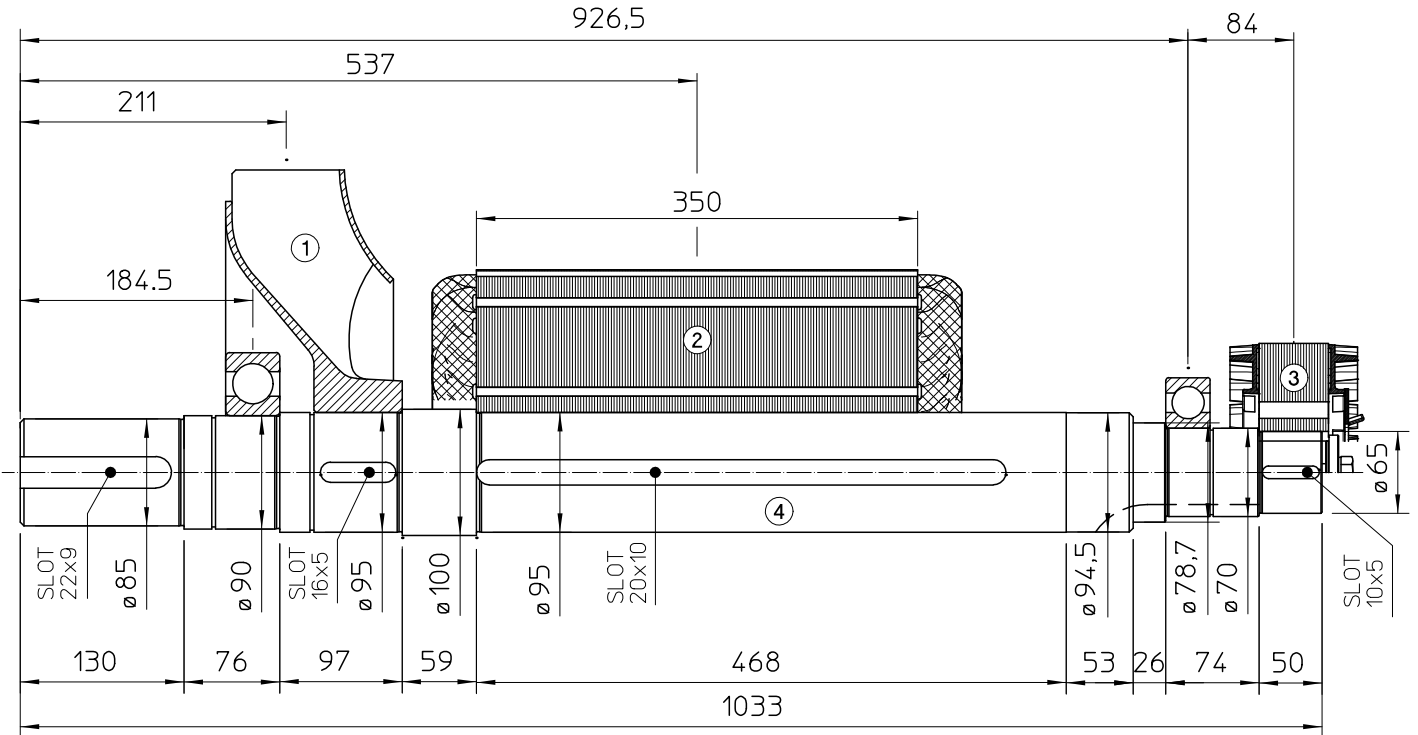

POS.	COMPONENT	WEIGHT (kg)	J (kgm ²)
1	FAN	6.1	0.1887
2	MAIN ROTOR	181	2.5056
3	EX. ROTOR	14.5	0.0874
4	SHAFT	49.9	0.0525
TOTAL		251.5	2.8342

TWO BEARING DIMENSIONS

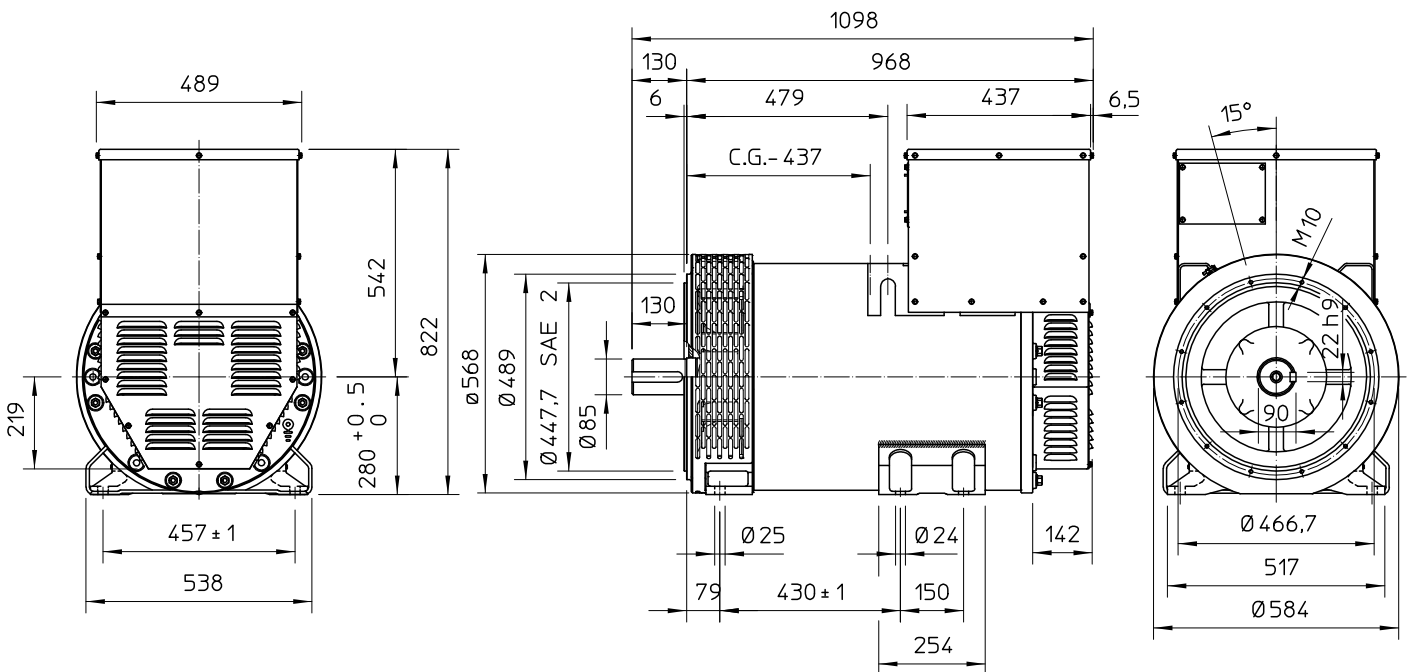

SINGLE BEARING MOMENTS OF INERTIA

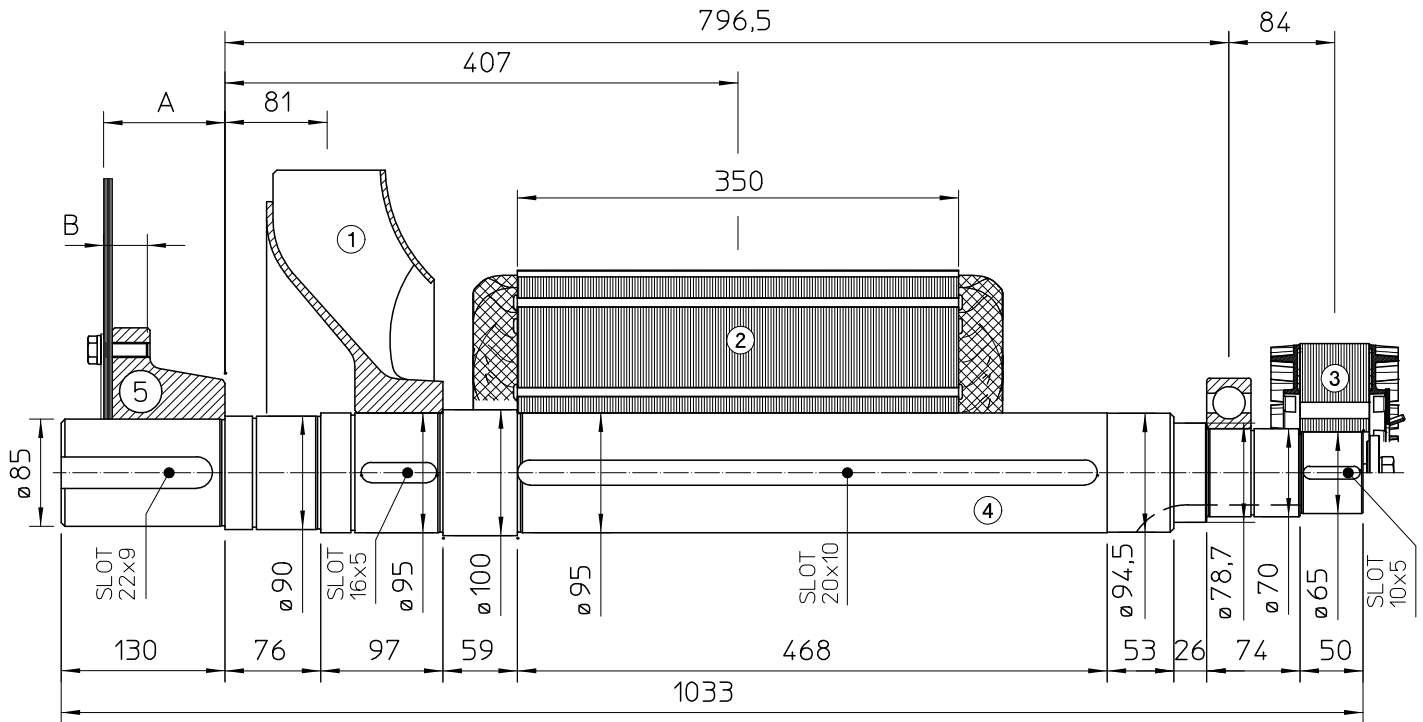

POS.	COMPONENT	WEIGHT (kg)	J (kgm ²)
1	FAN	6.1	0.1887
2	MAIN ROTOR	181	2.5056
3	EX. ROTOR	14.5	0.0874
4	SHAFT	49.9	0.0525
TOTAL		251.5	2.4382

SAE N°	5		SHAFTS COUPLING FLEX PLATE	
	A	B	WEIGHT kg	J kgm ²
11.5	110.4	41.1	20.5	0.174
14	96.4	34.7	23.5	0.275

SINGLE BEARING DIMENSIONS

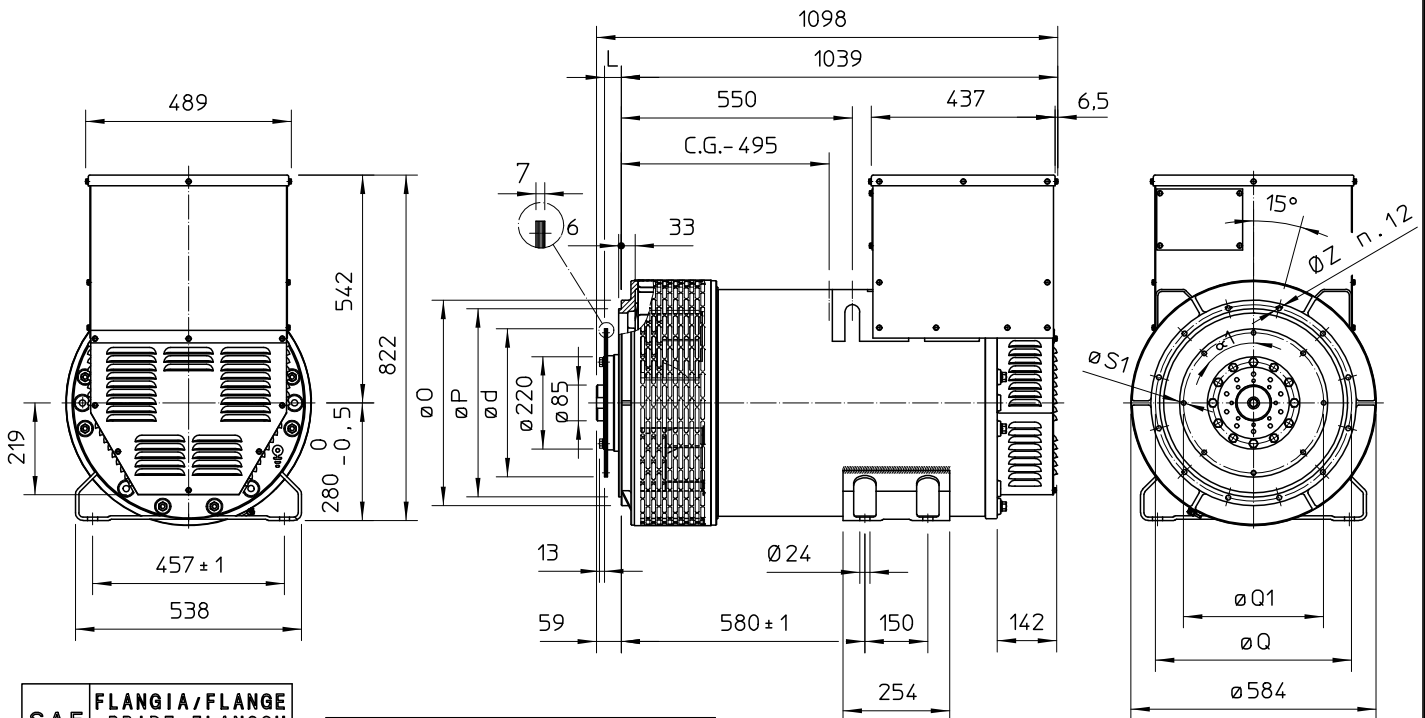

SAE N.	FLANGIA/FLANGE BRIDE/FLANSCH		
	O	P	Q
3	451	409,6	428,6
2	489	447,7	466,7
1	552	511,2	530,2
1/2	648	584,2	619,1

SAE N.	GIUNTI A DISCHI DISC COUPLING DISQUE DE MONOPALIER SCHEIBENKUPPLUNG					
	L	d	Q1	n _{fori}	S1	α1
11 1/2	39,6	352,42	333,37	8	11	45°
14	25,4	466,72	438,15	8	14	45°

C.G.= GRAVITY CENTER