

Electrical Characteristics										
Frequency	Hz	50				60				
Voltage (series star)	V	380	400	415	440	415	440	460	480	
Rated power class H	kVA	17	17	17	15,5	17,5	18,6	20,4	20,4	
	kW	13,6	13,6	13,6	12,4	14	14,9	16,3	16,3	
Rated power class F	kVA	16	16	16	14,5	16,5	17,5	19	19	
	kW	12,8	12,8	12,8	11,6	13,2	14	15,2	15,2	
Regulation with	SR7/2	±1,5 % with any power factor and speed variations between -5% +30%								
Insulation class		H								
Execution		Brushless								
Stator winding		12 ends								
Rotor		without damping cage								
Efficiencies class H	4/4	%	87,1	87,2	86,9	86,7	88	88,5	88,6	88,7
(see graph. for details)	3/4	%	87,1	87,4	87,3	87	88	88,2	88,4	88,6
	2/4	%	85,3	85,4	85,4	85,1	85,9	86	86,1	86,2
	1/4	%	83,2	83,1	82,9	82,4	83,3	83,1	83,2	83,5
Reactances (f. l.cl. F)	Xd	%	217,2	196	182,1	147,7	224,9	212,7	213,4	196
	Xd'	%	18,73	16,9	15,70	12,73	19,39	18,34	18,40	16,9
	Xd''	%	12,74	11,5	10,68	8,67	13,20	12,48	12,52	11,5
	Xq	%	79,8	72	66,9	54,3	82,6	78,1	78,4	72
	Xq'	%	79,8	72	66,9	54,3	82,6	78,1	78,4	72
	Xq''	%	26,6	24	22,3	18,1	27,5	26,0	26,1	24
	X ₂	%	18,84	17	15,79	12,81	19,51	18,45	18,51	17
	X ₀	%	3,99	3,6	3,34	2,71	4,13	3,91	3,92	3,6
Short Circuit Ratio	Kcc		0,55	0,67	0,88	1,50	0,42	0,50	0,55	0,67
Time Constants	Td'	sec.	0,051							
	Td''	sec.	0,018							
	Tdo'	sec.	0,90							
	T _α	sec.	0,016							
Short Circuit Current Capacity		%	>300				>320			
Excitation at no load	Amp.		0,4	0,5	0,6	0,9	0,25	0,32	0,35	0,4
Excitation at full load	Amp.		1,7	1,7	1,9	2,1	1,3	1,5	1,6	1,7
Overload (long-term)	%	1 hour in a 6 hours period 110% rated load								
Overload per 20 sec.	%	300								
Stator Winding Resistance (20°C)	Ω	0,283								
Rotor Winding Resistance (20°C)	Ω	1,260								
Exciter Resistance (20 °C)	Ω	Rotor : 0,417				Stator : 10,60				
Heat dissipation at f.l.cl.H	W	2014	1996	2050	1902	1909	1934	2100	2079	
Telephone Interference		THF < 2 %				TIF < 45				
Radio interference		EN60034-1. For others standards apply to factory								
Waveform Distors.(THD) at f. load	LL/LN %	2 / 2								
Waveform Distors.(THD) at no load	LL/LN %	3,7 / 3,7								
Mechanical characteristics										
Protection		IP 23 (other protection on request)								
DE bearing		6309-2RS								
NDE bearing		6209-2RS								
Weight of wound stator assembly	kg	33,2								
Weight of wound rotor assembly	kg	18								
Weight of complete generator	kg	107								
Maximun overspeed	rpm	2250								
Unbalanced magnetic pull at f.l.cl.F	kN/mm	3								
Cooling air requirement	m³/min	5,3				5,8				
Inertia Constant (H)	sec.	0,092				0,111				
Noise level at 1m/7m	dB(A)	68 / 57				71 / 61				

50 Hz

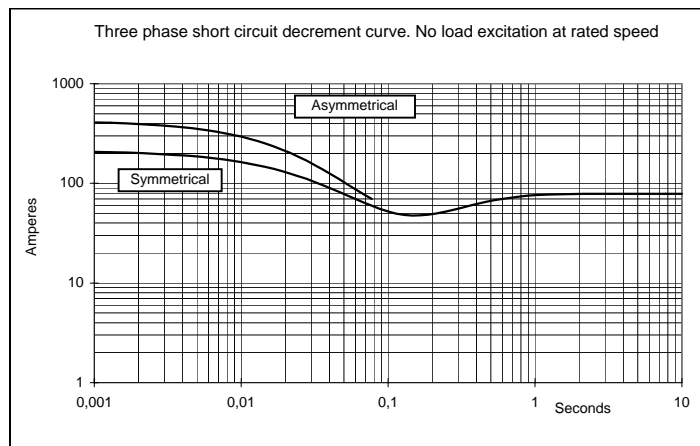

60 Hz

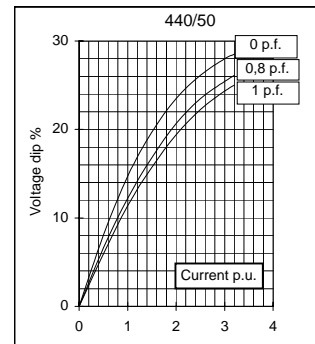
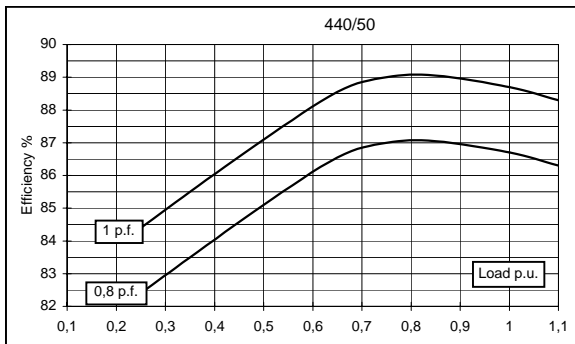
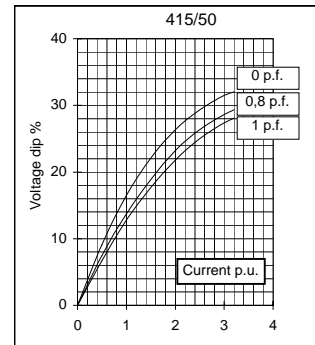
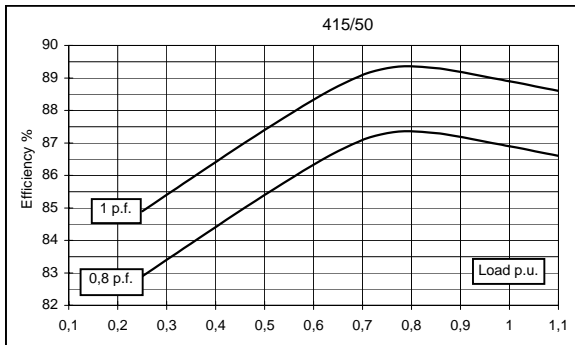
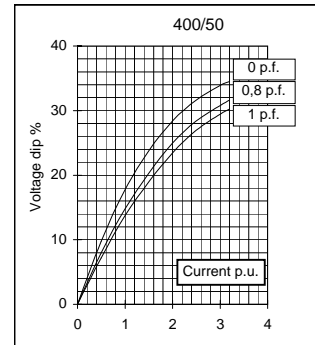
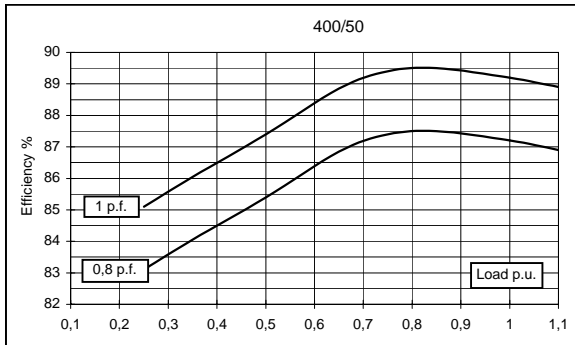
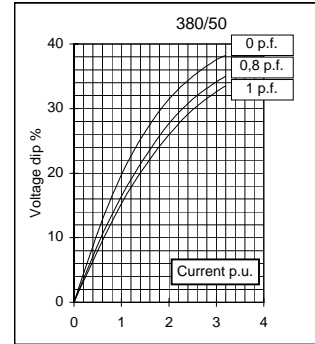
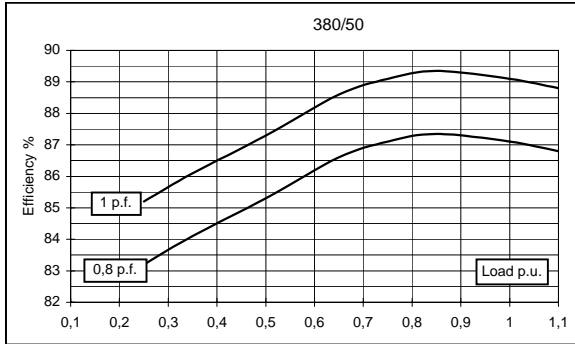
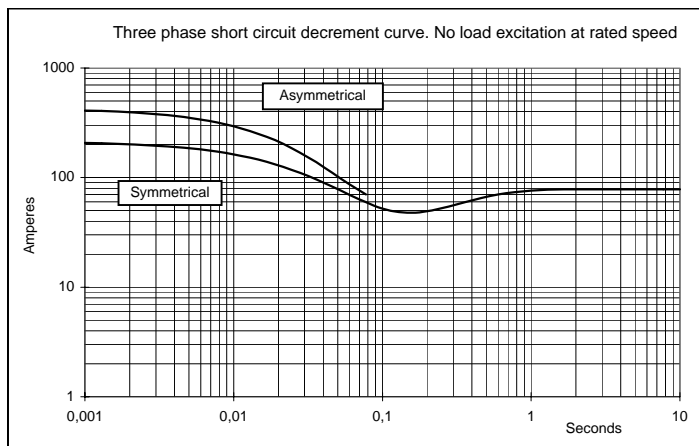
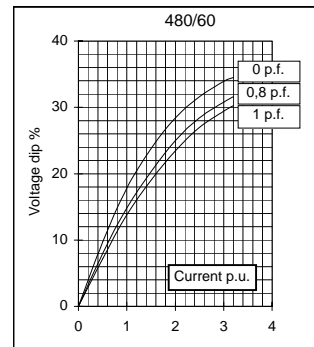
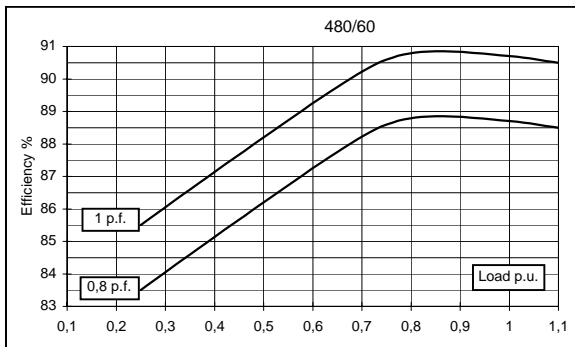
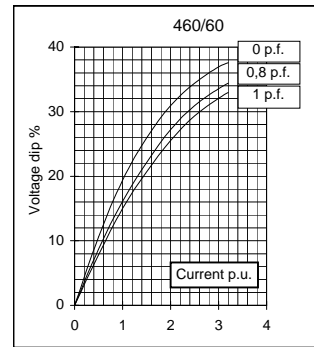
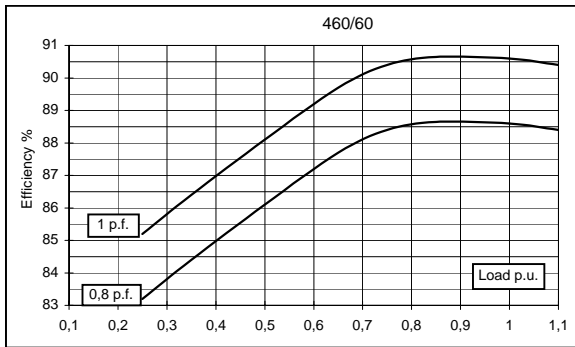
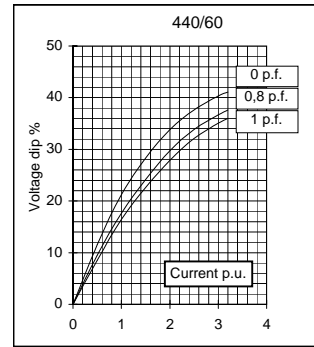
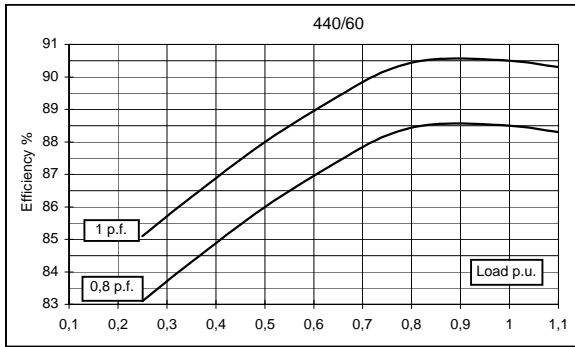
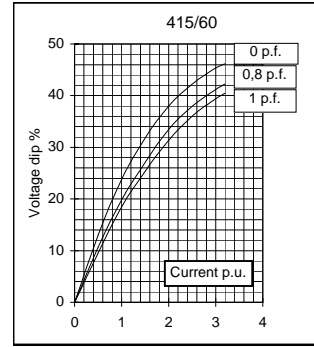
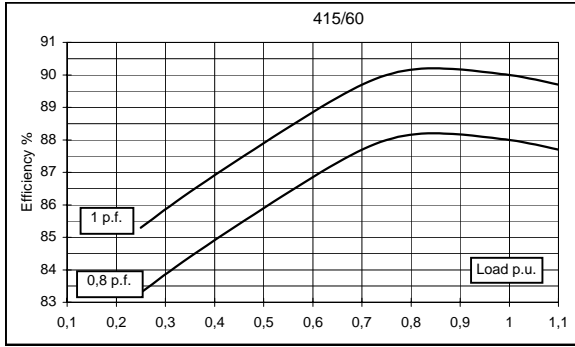

TWO BEARING MOMENTS OF INERTIA

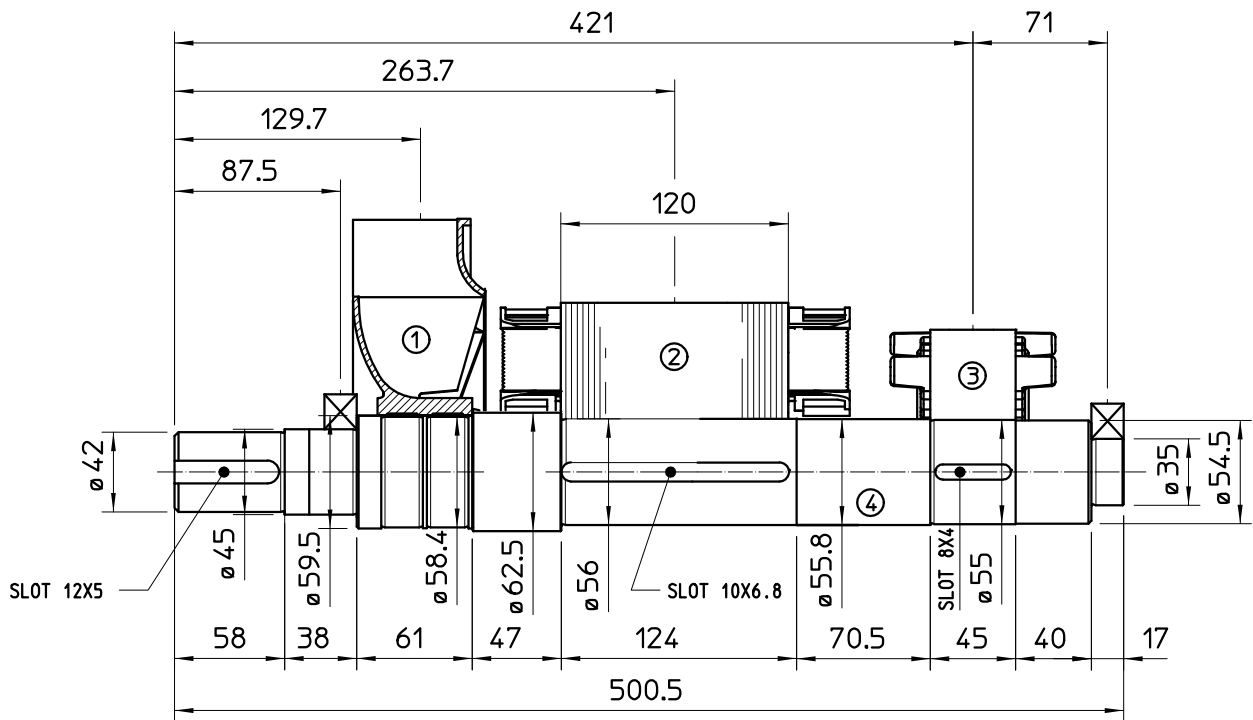

COMPONENT	WEIGHT Kg	J Kg ^m ²
1 FAN	1.2	0.0102
2 MAIN ROTOR	18	0.078
3 EX ROTOR	5.4	0.012
4 SHAFT	8.8	0.0035
6 TOTAL	33.4	0.1037

TWO BEARING DIMENSIONS

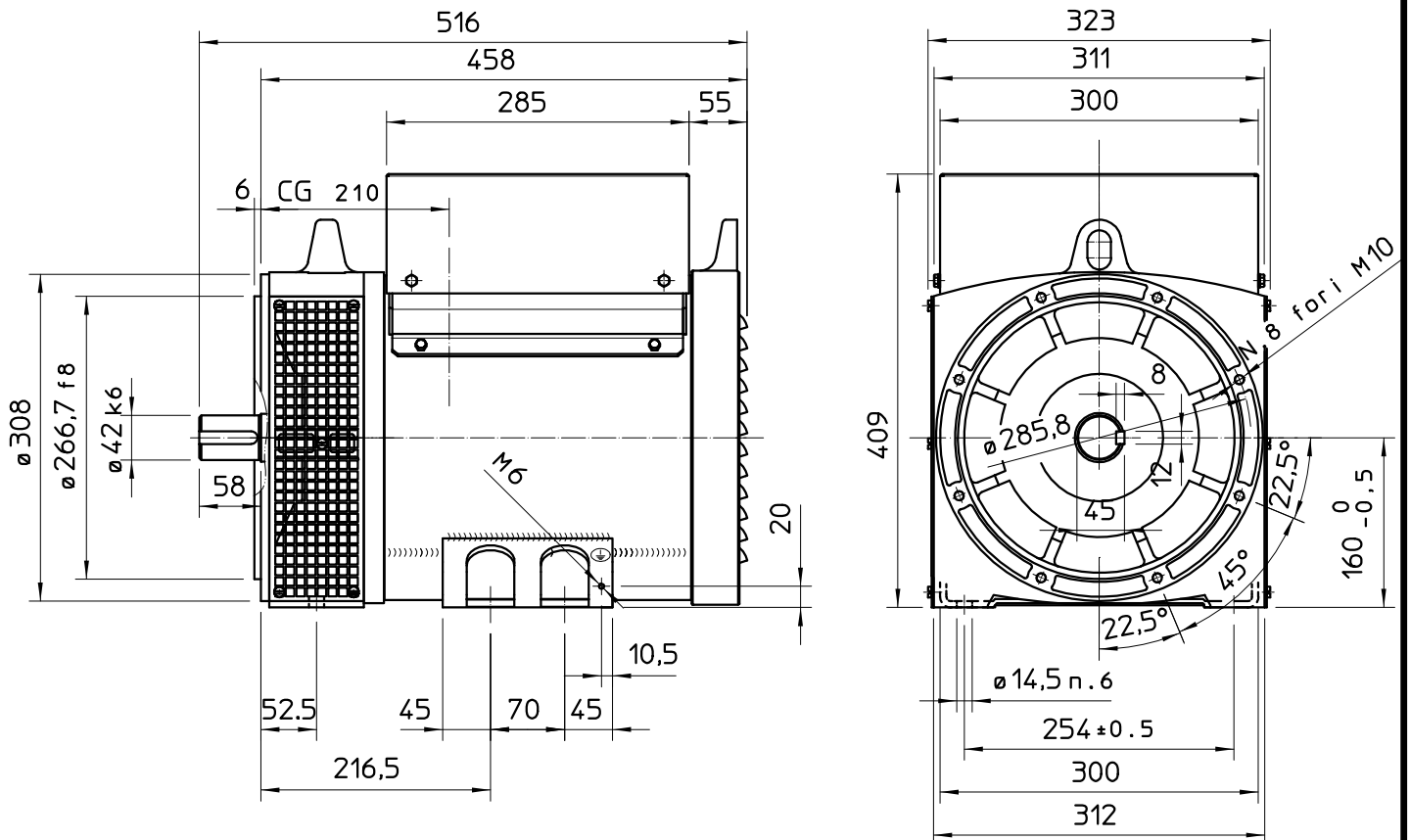

C.G. = GRAVITY CENTER

SINGLE BEARING MOMENTS OF INERTIA

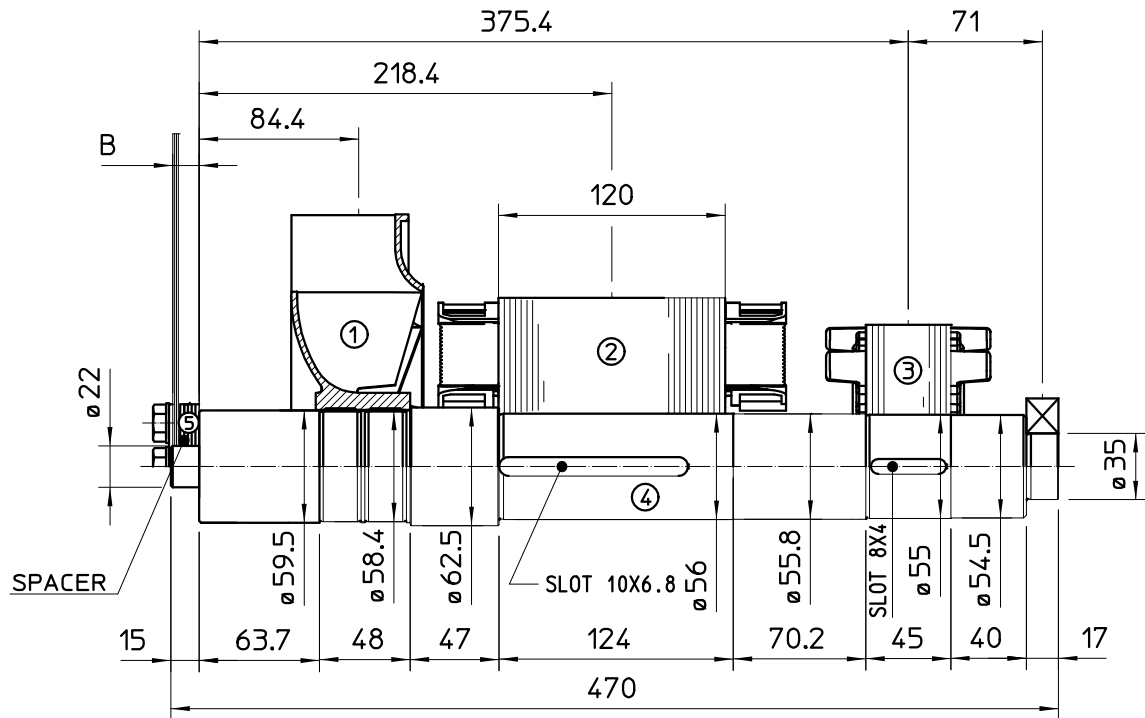

COMPONENT	WEIGHT Kg	J Kg ^m ²
1 FAN	1.2	0.0102
2 MAIN ROTOR	18	0.078
3 EX ROTOR	5.4	0.012
4 SHAFT	9	0.0037
6 TOTAL	33.6	0.1039

SAE N.	SHAFT COUPLING FLEX PLATE		
	B (mm)	WEIGHT kg	J kg ^m ²
6 1/2	4	1.14	0.0067
7 1/2	4	1.42	0.0103
8	35.6	1.97	0.0171
10	27.6	2.59	0.0319
11 1/2	14	3.1	0.0481

SINGLE BEARING DIMENSIONS

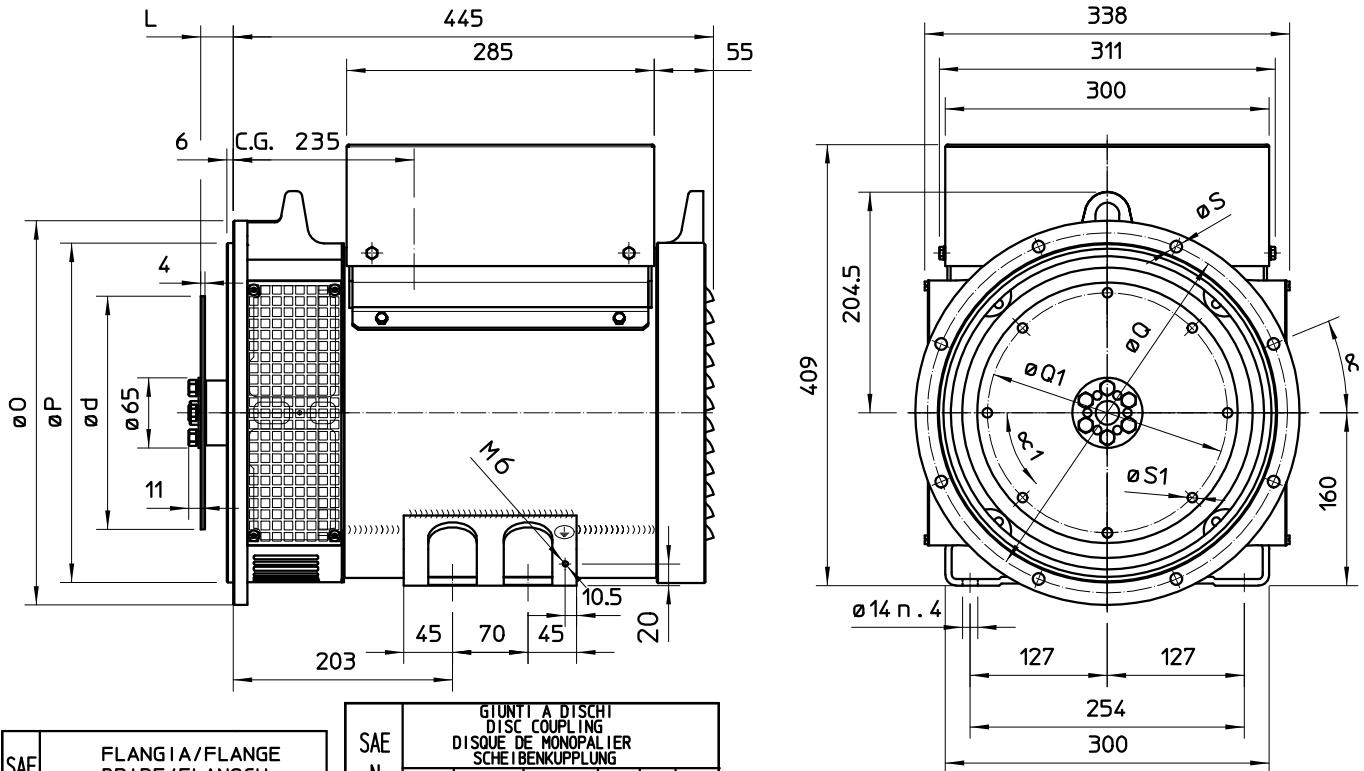

SAE N.	FLANGIA/FLANGE BRIDE/FLANSCH					
	O	P	Q	n. for i	S	α
5	356	314.3	333.4	8	11	22°30'
4	403	362	381	12	11	15°
3	451	409.6	428.6	12	11	15°
2	489	447.7	466.7	12	11	15°

SAE N.	GIUNTI A DISCHI DISC COUPLING DISQUE DE MONOPALIER SCHEIBENKUPPLUNG					
	L	d	Q1	n. for i	S1	α1
6 1/2	30.2	215.9	200	6	9	60°
7 1/2	30.2	241.3	222.25	8	9	45°
8	62	263.52	244.47	6	11	60°
10	53.8	314.32	295.27	8	11	45°
11 1/2	39.6	352.42	333.37	8	11	45°

C.G. = GRAVITY CENTER