

Electrical Characteristics										
Frequency	Hz	50				60				
Voltage (series star)	V	380	400	415	440	415	440	460	480	
Rated power class H	kVA	60	60	60	50	60	68	72	72	
	kW	48	48	48	40	48	54,4	57,6	57,6	
Rated power class F	kVA	57	57	57	45	55	65	69	69	
	kW	45,6	45,6	45,6	36	44	52	55,2	55,2	
Regulation with SR7/2		±1,5 % with any power factor and speed variations between -5% +30%								
Insulation class		H								
Execution		Brushless								
Stator winding		12 ends								
Rotor		with damping cage								
Efficiencies class H	4/4	%	90,2	90,3	90	89,5	92,2	92,7	92,8	92,9
(see graph. for details)	3/4	%	90,5	90,8	90,7	90,4	92,7	92,9	93,1	93,3
	2/4	%	89,4	89,5	89,5	89,5	90,8	90,9	91	91,1
	1/4	%	86,2	86	85,8	85,5	87	87	87	87
Reactances (f. l.cl. F)	Xd	%	299,2	270	250,8	186,0	301,0	303,5	294,0	270
	Xd'	%	14,18	12,8	11,89	8,82	14,27	14,39	13,94	12,8
	Xd''	%	7,53	6,8	6,32	4,68	7,58	7,64	7,40	6,8
	Xq	%	117,5	106	98,5	73,0	118,2	119,1	115,4	106
	Xq'	%	117,5	106	98,5	73,0	118,2	119,1	115,4	106
	Xq''	%	36,6	33	30,7	22,7	39,6	34,9	33,0	33
	X ₂	%	24,71	22,3	20,72	15,36	24,86	25,06	24,28	22,3
	X ₀	%	3,32	3	2,79	2,07	3,34	3,37	3,27	3
Short Circuit Ratio	Kcc		0,48	0,60	0,70	1,30	0,35	0,40	0,48	0,60
Time Constants	Td'	sec.	0,062							
	Td''	sec.	0,014							
	Tdo'	sec.	1,20							
	Tα	sec.	0,028							
Short Circuit Current Capacity		%	>300				>350			
Excitation at no load	Amp.		0,5	0,6	0,7	1	0,3	0,4	0,45	0,6
Excitation at full load	Amp.		1,9	1,9	2,4	2,8	1,6	1,7	1,8	2
Overload (long-term)		%	1 hour in a 6 hours period 110% rated load							
Overload per 20 sec.		%	300							
Stator Winding Resistance (20°C)	Ω		0,041							
Rotor Winding Resistance (20°C)	Ω		2,861							
Exciter Resistance (20 °C)	Ω		Rotor : 0,442				Stator : 11,35			
Heat dissipation at f.l.cl.H	W		5215	5156	5333	4693	4061	4284	4469	4402
Telephone Interference			FHT < 2%				TIF < 45			
Radio interference			EN50081-1, EN50082-1, VDE0875K. For others standards apply to factory							
Waveform Distors.(THD) at f. load	LL/LN %		3,8 / 3,6							
Waveform Distors.(THD) at no load	LL/LN %		3 / 2,9							
Mechanical characteristics										
Protection			IP 21 (other protection on request)							
DE bearing			6312-2RS							
NDE bearing			6309-2RS							
Weight of wound stator assembly	kg		95							
Weight of wound rotor assembly	kg		64							
Weight of complete generator	kg		282							
Maximun overspeed	rpm		2250							
Unbalanced magnetic pull at f.l.cl.F	kN/mm		4,7							
Cooling air requirement	m ³ /min		11,8				14,5			
Inertia Constant (H)	sec.		0,104				0,125			
Noise level at 1m/7m	dB(A)		75 / 60				79 / 64			

50 Hz

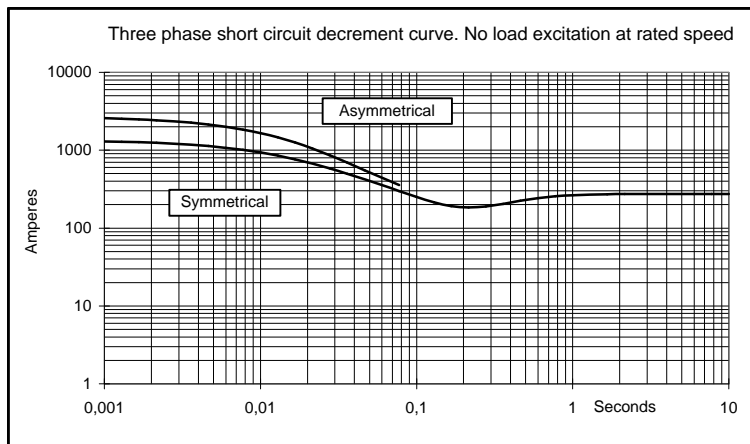

60 Hz

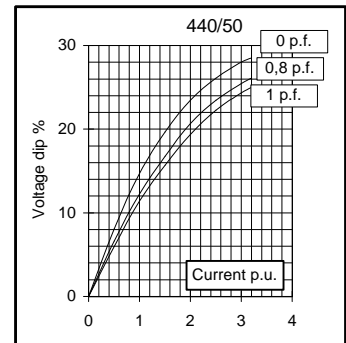
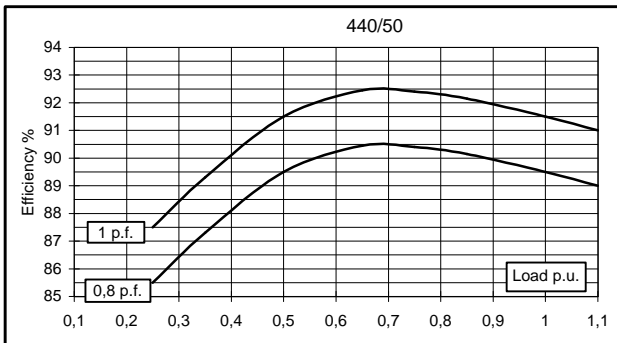
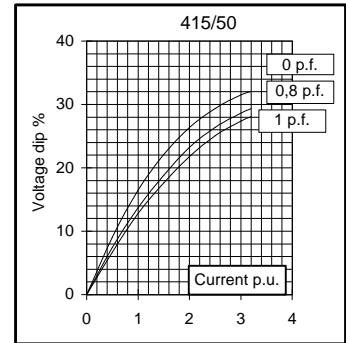
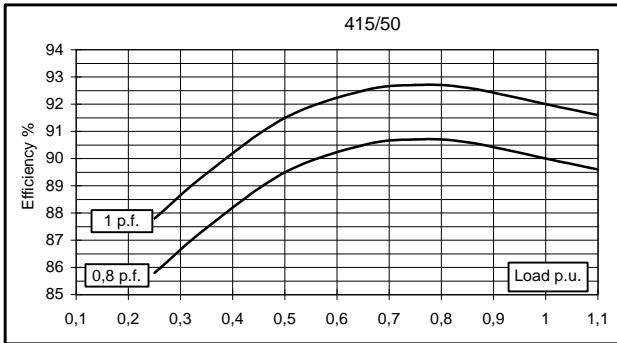
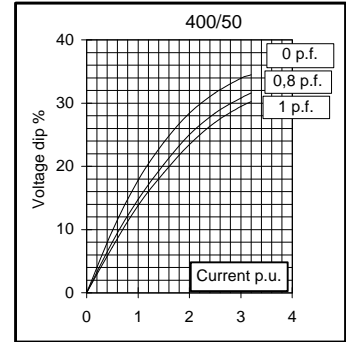
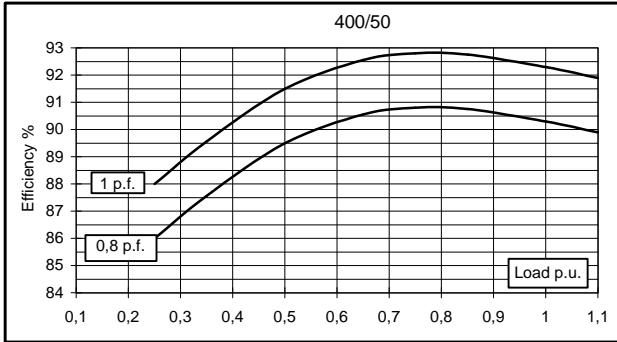
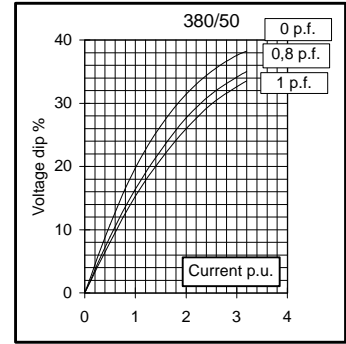
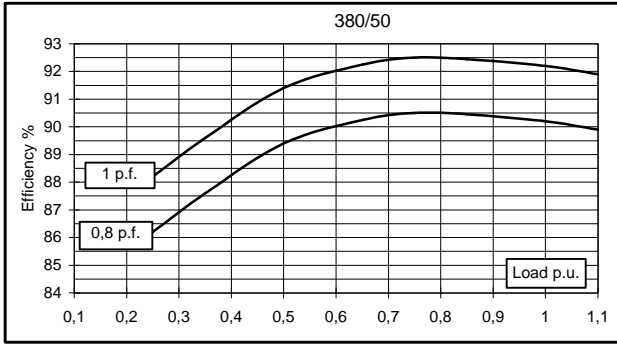
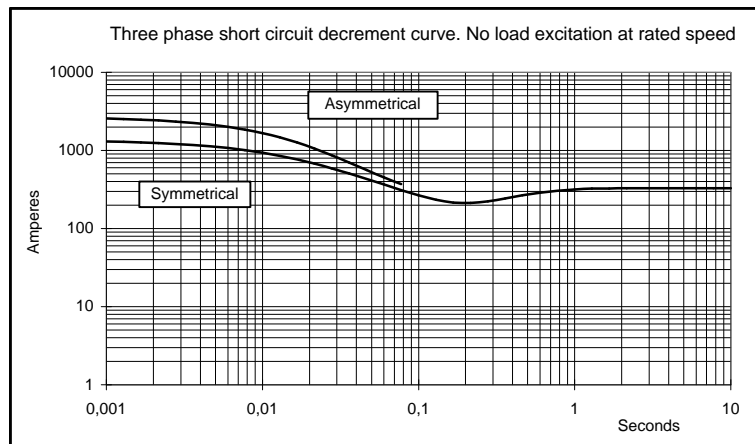
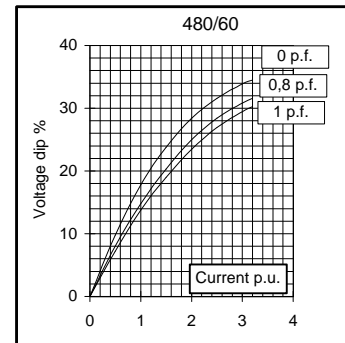
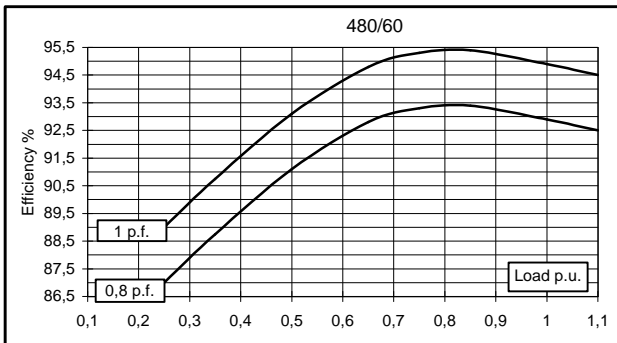
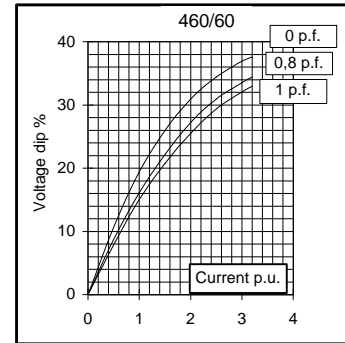
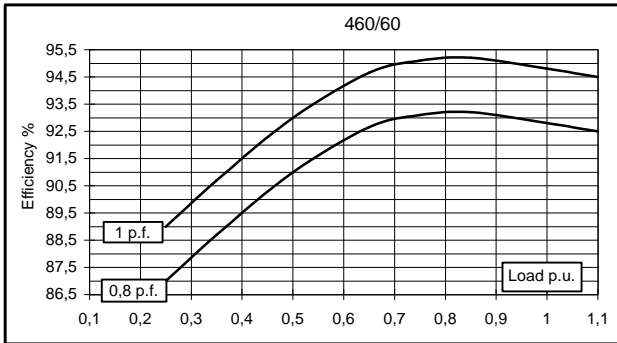
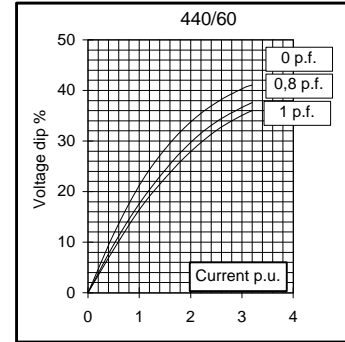
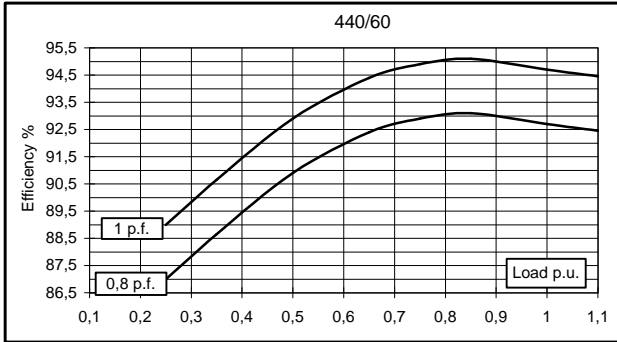
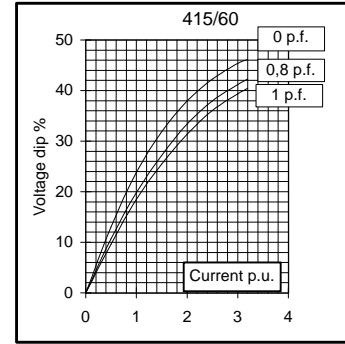
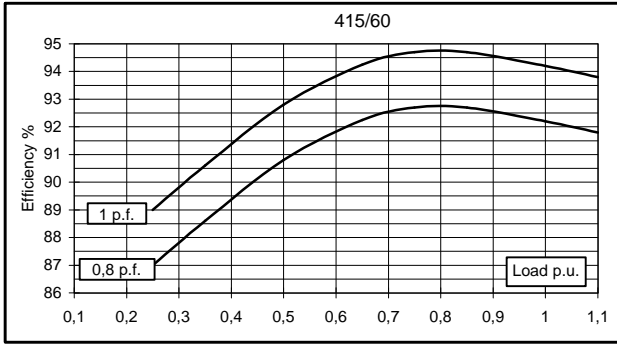

TWO BEARING MOMENTS OF INERTIA

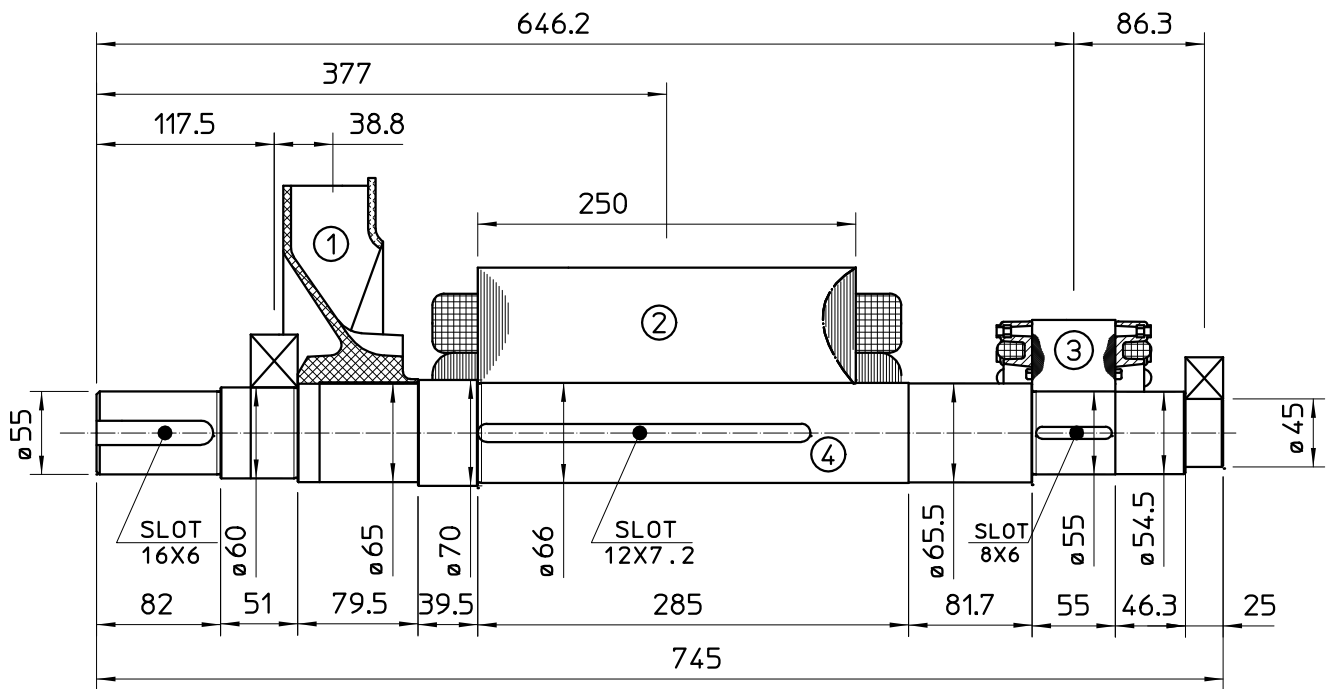

COMPONENT	WEIGHT kg	J kgm ²
1 FAN	2,3	0,0224
2 MAIN ROTOR	64,5	0,4579
3 EX. ROTOR	7	0,016
4 SHAFT	17,5	0,008
TOTAL	91,3	0,5043

TWO BEARING DIMENSIONS

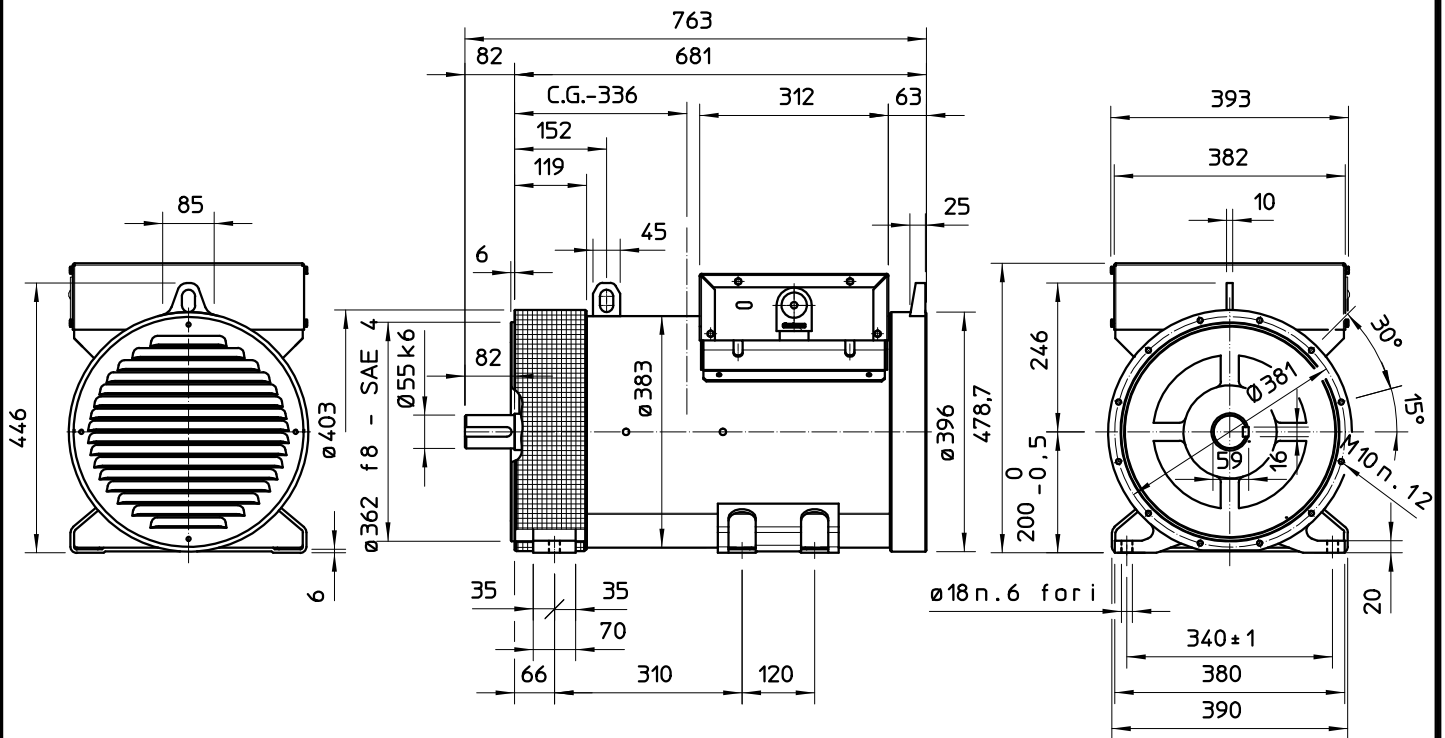

C.G. = GRAVITY CENTER

SINGLE BEARING MOMENTS OF INERTIA

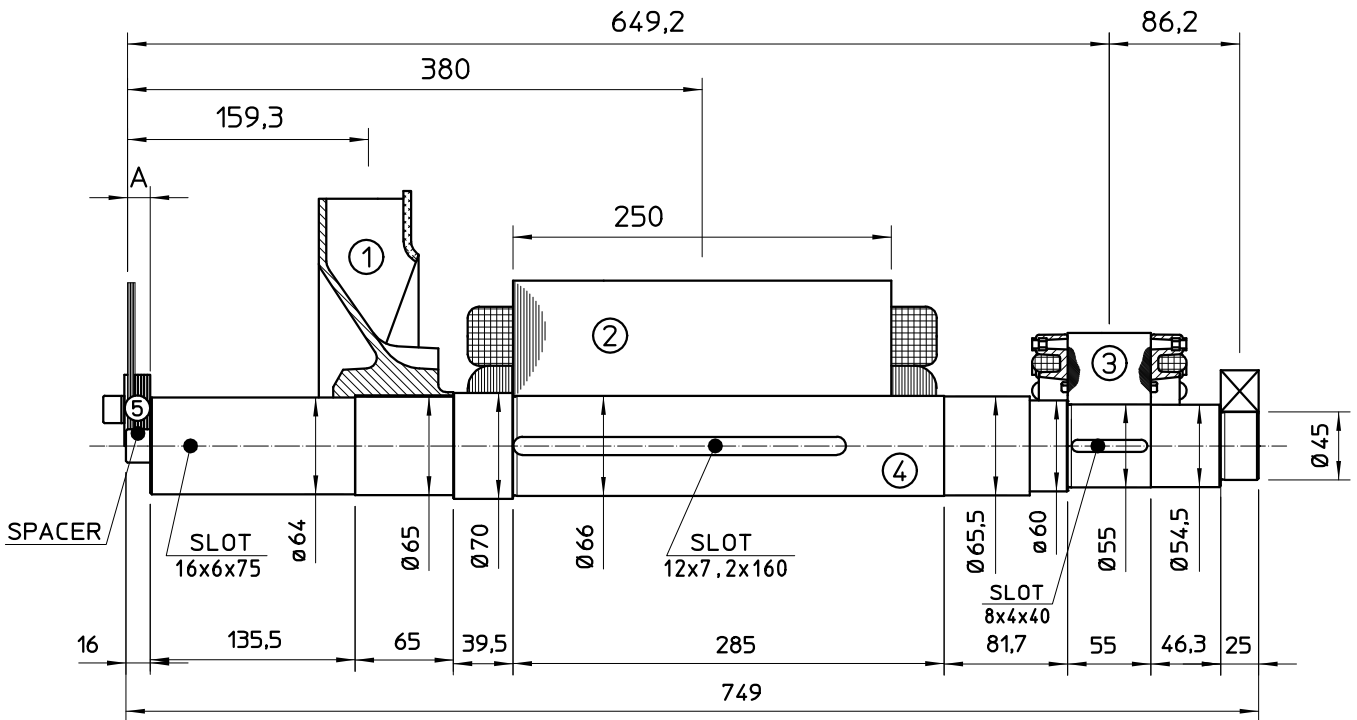

COMPONENT	WEIGHT kg	J kgm ²
1 FAN	2,3	0,0224
2 MAIN ROTOR	64,5	0,4579
3 EX. ROTOR	7	0,016
4 SHAFT	18,3	0,0094
TOTAL	92,1	0,5057

SAE No	SHAFTS COUPLING FLEX PLATE			
	A (mm)	WEIGHT kg	J kgm ²	
6,5	5	1,74	0,0084	
7,5	5	2,1	0,013	
8	36,6	3,9	0,02	
10	28,6	4,47	0,038	
11,5	15	4,51	0,059	

SINGLE BEARING DIMENSIONS

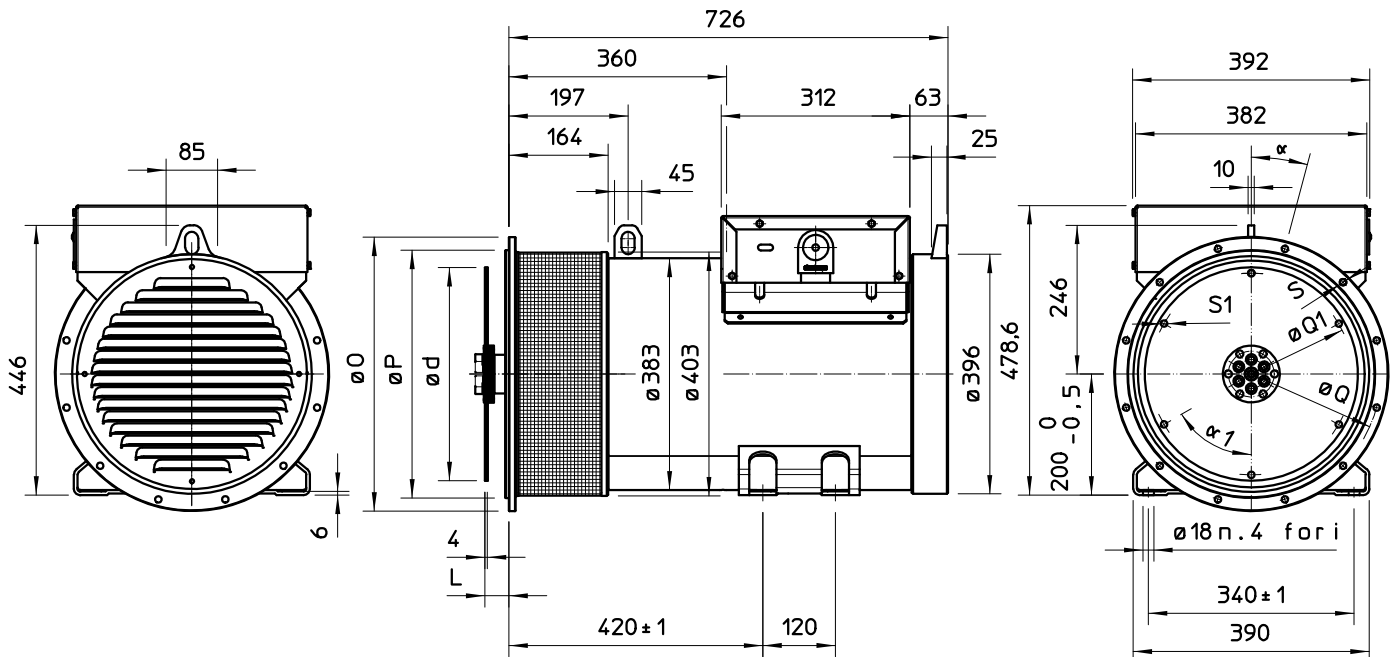

SAE No	DISC COUPLING					
	L	d	Q1	No holes	S1	a1
6,5	30,2	215,9	200	6	9	60°
7,5	30,2	241,3	222,25	8	9	45°
8	62	263,52	244,47	6	11	60°
10	53,8	314,32	295,27	8	11	45°
11,5	39,6	352,42	333,37	8	11	45°

SAE No	FLANGE					
	O	P	Q	No holes	S	a
5	356	314,3	333,4	8	11	22°30'
4	403	362	381	12	11	15°
3	451	409,6	428,6	12	11	15°
2	489	447,7	466,7	12	11	15°
1	552	511,2	530,2	12	11	15°

C.G. = GRAVITY CENTER