

Electrical Characteristics										
Frequency	Hz	50				60				
Voltage (series star)	V	380	400	415	440	415	440	460	480	
Rated power class H	kVA	225	225	225	210	260	270	270	270	
	kW	180	180	180	168	208	216	216	216	
Rated power class F	kVA	207	207	207	190	240	250	250	250	
	kW	166	166	166	152	192	200	200	200	
Regulation with UVR6		±1 % with any power factor and speed variations between -5% +30%								
Insulation class		H								
Execution		Brushless								
Stator winding		12 ends								
Rotor		with damping cage								
Efficiencies class H	4/4	%	93	93,1	92,8	92,6	93,6	94,1	94,2	94,3
(see graph. for details)	3/4	%	93,1	93,4	93,3	93	94	94,2	94,4	94,6
	2/4	%	92	92,1	92,1	91,9	93,2	93,3	93,4	93,5
	1/4	%	89,7	89,5	89,3	89,1	90,7	90,7	90,7	90,5
Reactances (f. l.cl. F)	Xd	%	221,6	200	185,8	154,3	257,6	238,0	217,8	200
	Xd'	%	14,2	12,8	11,9	9,9	16,5	15,2	13,9	12,8
	Xd''	%	7,5	6,8	6,3	5,2	8,8	8,1	7,4	6,8
	Xq	%	121,9	110	102,2	84,8	141,7	130,9	119,8	110
	Xq'	%	121,9	110	102,2	84,8	141,7	130,9	119,8	110
	Xq''	%	25,6	23,1	21,5	17,8	29,8	27,5	25,2	23,1
	X ₂	%	17,7	16,0	14,9	12,3	20,6	19,0	17,4	16,0
	X ₀	%	3,0	2,7	2,5	2,1	3,5	3,2	2,9	2,7
Short Circuit Ratio	Kcc		0,40	0,43	0,65	1,10	0,30	0,35	0,40	0,43
Time Constants	Td'	sec.	0,085							
	Td''	sec.	0,0135							
	Tdo'	sec.	1,20							
	Tα	sec.	0,0185							
Short Circuit Current Capacity		%	>300				>350			
Excitation at no load	Amp.		0,55	0,67	0,8	1,1	0,3	0,4	0,5	0,65
Excitation at full load	Amp.		2,7	2,9	3,1	3,2	2,3	2,4	2,6	2,8
Overload (long-term)		%	1 hour in a 6 hours period 110% rated load							
Overload per 20 sec.		%	300							
Stator Winding Resistance (20°C)	Ω		0,0091							
Rotor Winding Resistance (20°C)	Ω		3,960							
Exciter Resistance (20 °C)	Ω		Rotor : 0,410				Stator : 15,28			
Heat dissipation at f.l.cl.H	W		13548	13340	13966	13425	14222	13543	13299	13056
Telephone Interference			FHT < 2%				TIF < 40			
Radio interference			EN50081-1, EN50082-1, VDE0875K. For others standards apply to factory							
Waveform Distors.(THD) at f. load	LL/LN %		2,8 / 2,9							
Waveform Distors.(THD) at no load	LL/LN %		2,6 / 2,8							
Mechanical characteristics										
Protection			IP 21 (other protection on request)							
DE bearing			6318.2RS							
NDE bearing			6314.2RS							
Weight of wound stator assembly	kg		201							
Weight of wound rotor assembly	kg		132,8							
Weight of complete generator	kg		602							
Maximun overspeed	rpm		2250							
Unbalanced magnetic pull at f.l.cl.F	kN/mm		5,7							
Cooling air requirement	m ³ /min		32				39			
Inertia Constant (H)	sec.		0,115				0,138			
Noise level at 1m/7m	dB(A)		82 / 69				86 / 73			

50 Hz

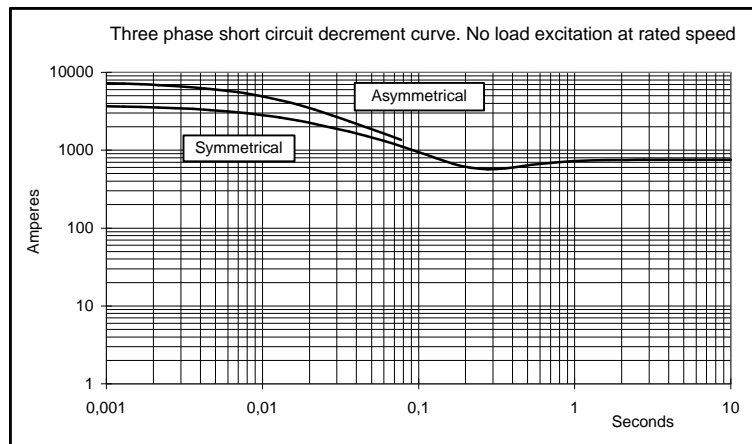

60 Hz

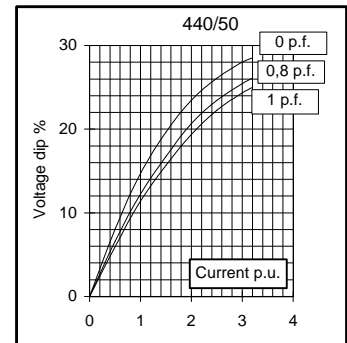
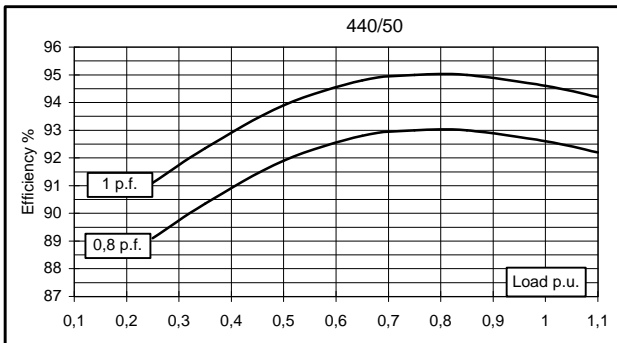
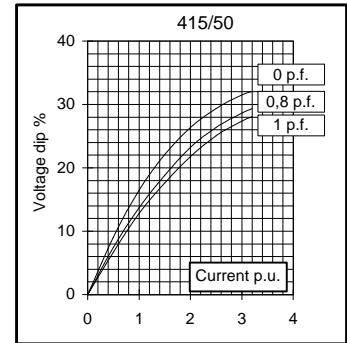
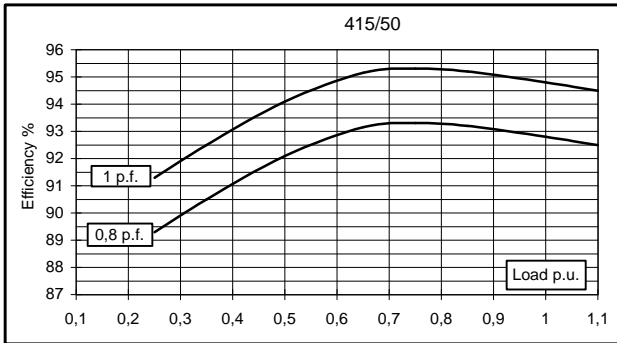
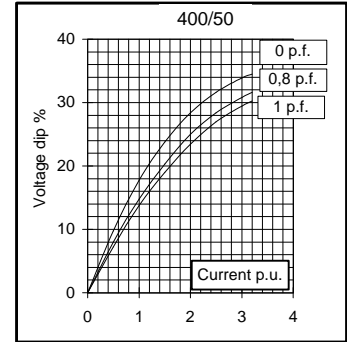
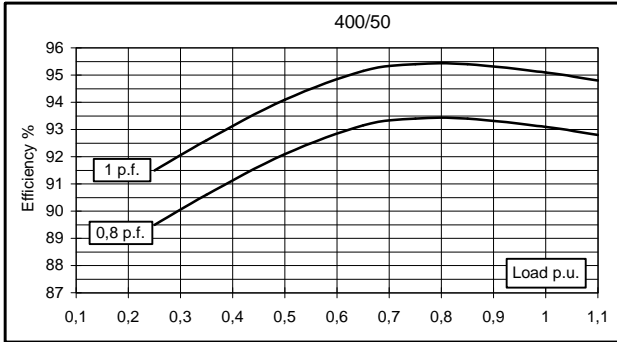
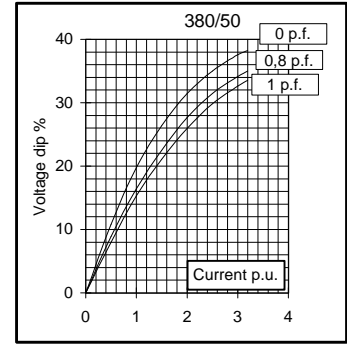
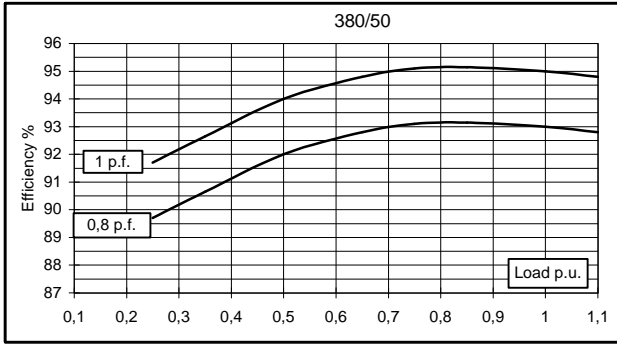
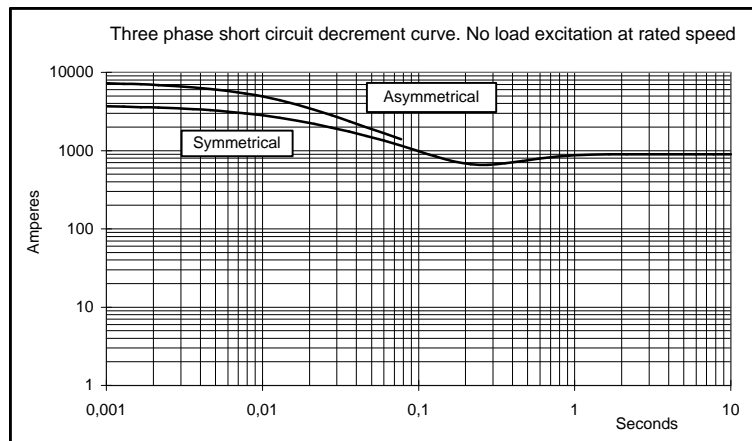
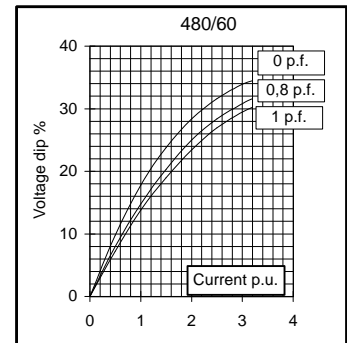
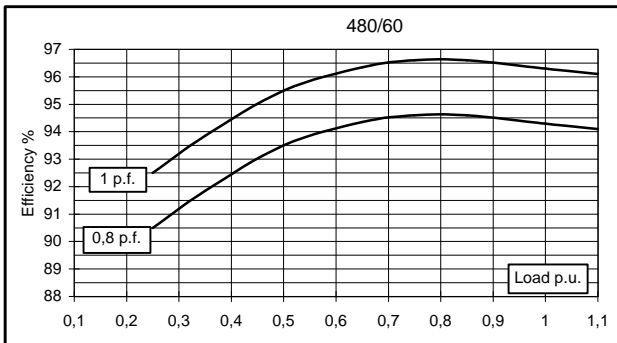
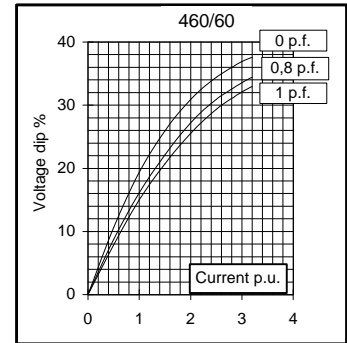
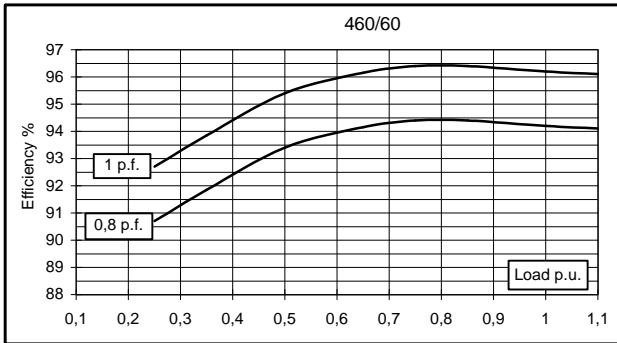
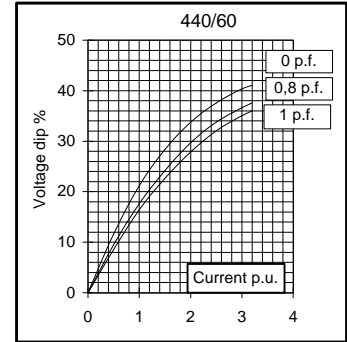
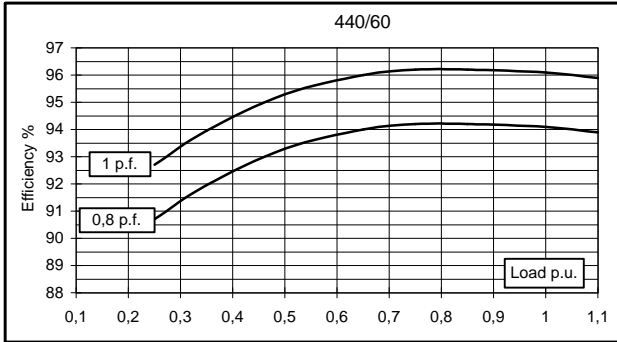
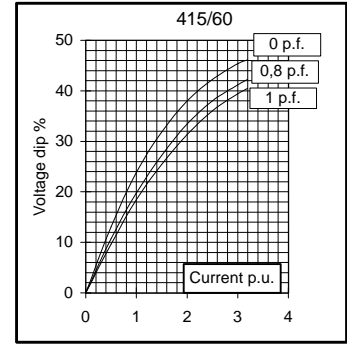
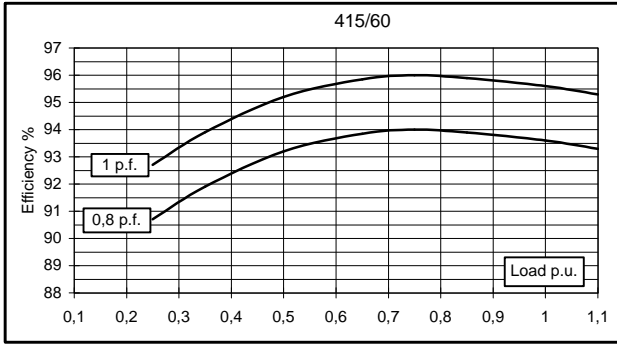

TWO BEARING MOMENTS OF INERTIA

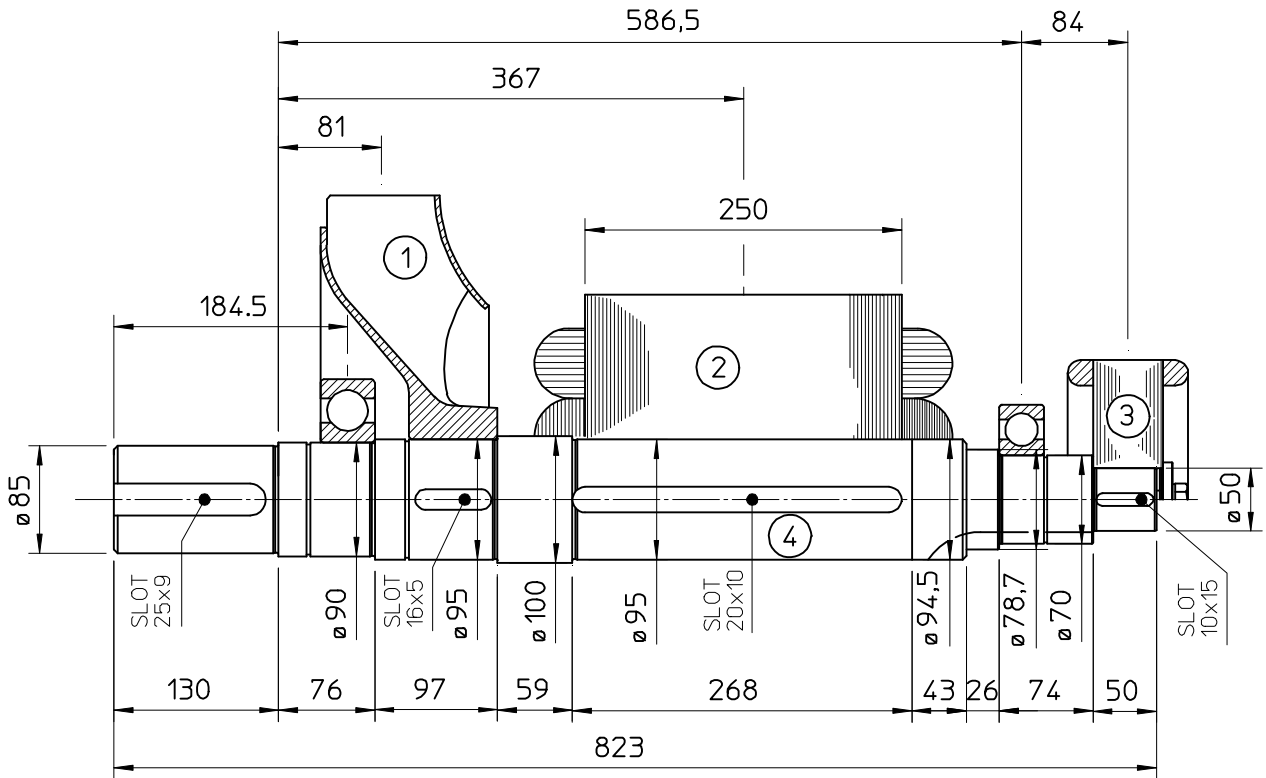

COMPONENT	WEIGHT kg	J kgm ²
1 FAN	6,1	0,1887
2 MAIN ROTOR	132,8	1,7815
3 EX. ROTOR	14,5	0,0874
4 SHAFT	38,5	0,0397
TOTAL	191,9	2,0973

TWO BEARING DIMENSIONS

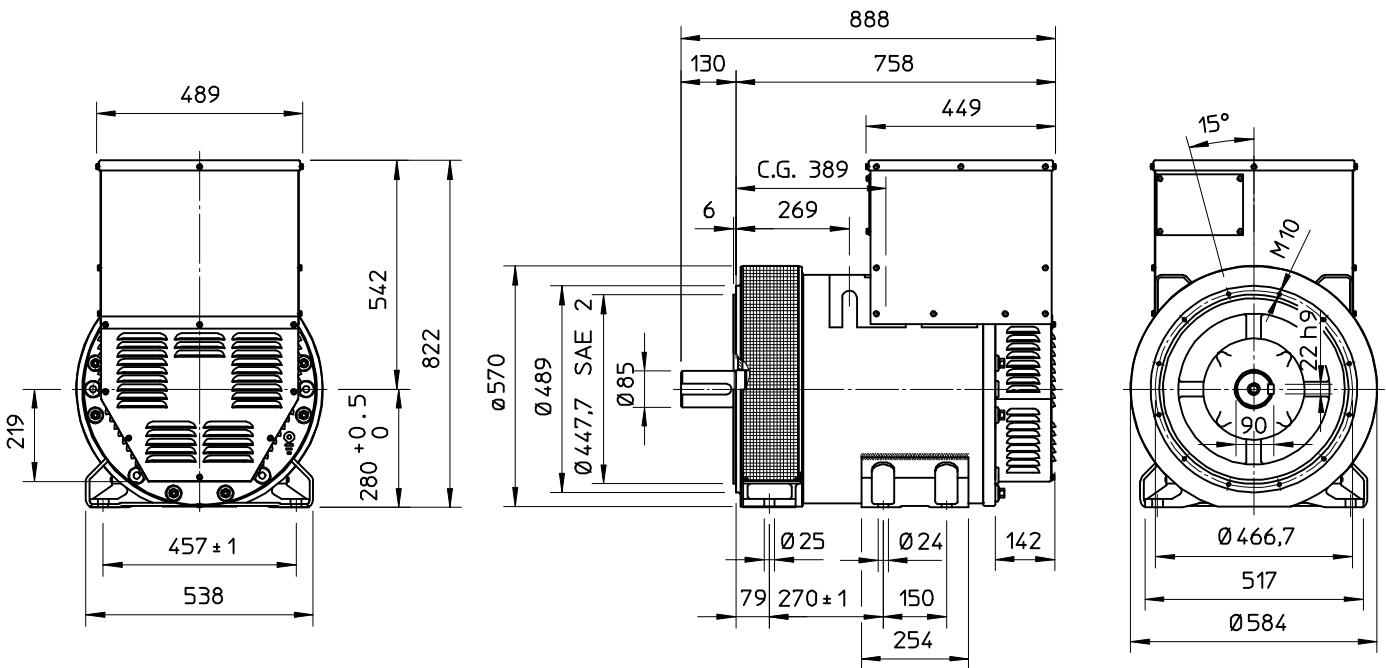

C.G = GRAVITY CENTER

SINGLE BEARING MOMENTS OF INERTIA

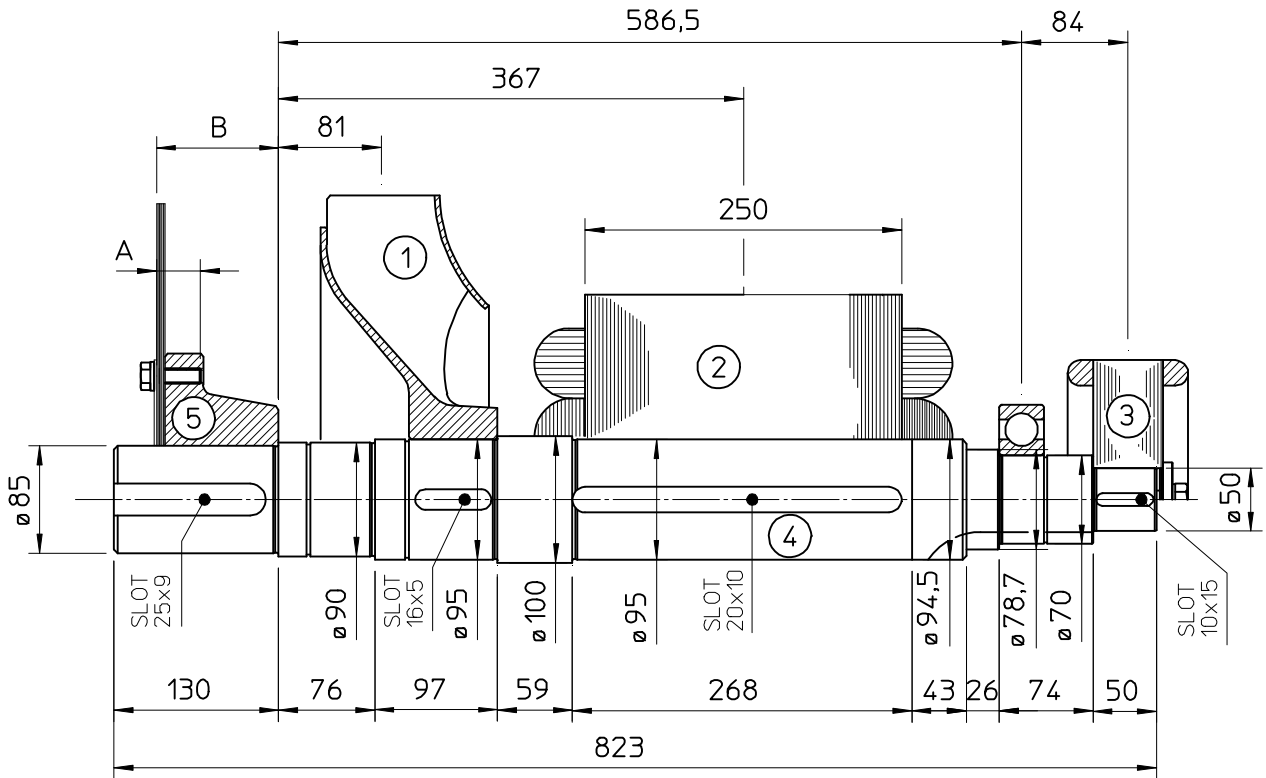

	COMPONENT	WEIGHT kg	J kgm ²
1	FAN	6,1	0,1887
2	MAIN ROTOR	132,8	1,7815
3	EX. ROTOR	14,5	0,0874
4	SHAFT	38,5	0,0397
	TOTAL	191,9	2,0973

SAE No	SHAFTS COUPLING FLEX PLATE			
	A	B	WEIGHT kg	J kgm ²
5				
11.5	41.1	110.4	22,7	0,306
14	34.7	96.4	22,7	0,306

SINGLE BEARING DIMENSIONS

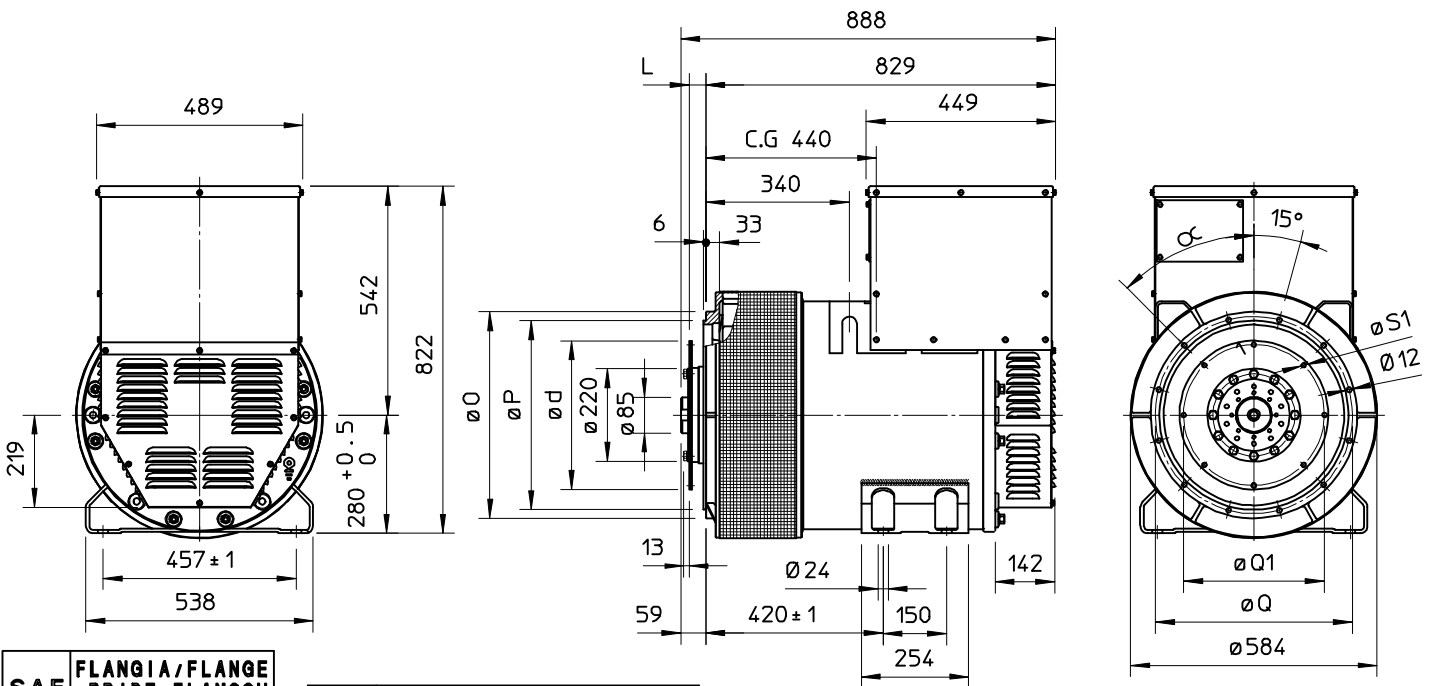

SAE N.	FLANGIA/FLANGE BRIDE/FLANSCH		
	O	P	Q
3	451	409,6	428,6
2	489	447,7	466,7
1	552	511,2	530,2
1/2	648	584,2	619,1

SAE N.	GIUNTI A DISCHI DISC COUPLING DISQUE DE MONOPALIER SCHEIBENKUPPLUNG					
	L	d	Q1	n. fori	S1	α1
11 1/2	39,6	352,42	333,37	8	11	45°
14	25,4	466,72	438,15	8	14	45°

C.G = GRAVITY CENTER