



GENERATOR TYPE ECP 34-1S/4 A

Document : DS272A/1

issue 000 date 11/10/2013

Electrical Characteristics										
Frequency	Hz	50				60				
Voltage (series star)	V	380	400	415	440	415	440	460	480	
Rated power class H	kVA	85	85	85	70	95	102	102	102	
	kW	68	68	68	56	76	81,6	81,6	81,6	
Rated power class F	kVA	77	77	77	63	85,5	92	92	92	
	kW	61,6	61,6	61,6	50,4	68,4	73,6	73,6	73,6	
Regulation with DSR		±1 % with any power factor and speed variations between -5% +30%								
Insulation class		H								
Execution		Brushless								
Stator winding		12 ends								
Rotor		with damping cage								
Efficiencies class H	4/4	%	91,4	91,5	91,2	91	92,7	93,2	93,3	93,4
(see graph. for details)	3/4	%	91,6	91,9	91,8	91,5	93,3	93,5	93,6	93,8
	2/4	%	89,9	90	90	89,8	91,5	91,6	91,7	91,8
	1/4	%	86,2	86	85,8	85,8	87,7	87,7	87,7	87,5
Reactances (f. l.cl. F)	Xd	%	360,1	325	301,9	221,2	404,9	386,8	353,9	325
	Xd'	%	24,7	22,3	20,7	15,2	27,8	26,5	24,3	22,3
	Xd''	%	8,2	7,4	6,9	5,0	9,2	8,8	8,1	7,4
	Xq	%	188,9	170,5	158,4	116,0	212,4	202,9	185,6	170,5
	Xq'	%	188,9	170,5	158,4	116,0	212,4	202,9	185,6	170,5
	Xq''	%	32,7	29,5	27,4	20,1	36,8	35,1	32,1	29,5
	X ₂	%	21,3	19,2	17,8	13,1	23,9	22,8	20,9	19,2
	X ₀	%	4,0	3,6	3,3	2,5	4,5	4,3	3,9	3,6
Short Circuit Ratio	Kcc		0,45	0,50	0,62	1,07	0,35	0,40	0,45	0,50
Time Constants	Td'	sec.	0,04192							
	Td''	sec.	0,00575							
	Tdo'	sec.	1,50							
	Tα	sec.	0,0154							
Short Circuit Current Capacity		%	>300				>350			
Excitation at no load	Amp.		0,4	0,5	0,7	1	0,2	0,3	0,4	0,7
Excitation at full load	Amp.		2,2	2,3	2,5	2,8	1,9	2	2,1	2,2
Overload (long-term)		%	1 hour in a 6 hours period 110% rated load							
Overload per 20 sec.		%	300							
Stator Winding Resistance (20 °C)	Ω		0,03							
Rotor Winding Resistance (20 °C)	Ω		2,477							
Exciter Resistance (20 °C)	Ω		Rotor : 0,410				Stator : 15,28			
Heat dissipation at f.l.cl.H	W		6398	6317	6561	5538	5985	5954	5860	5766
Telephone Interference			THF < 2%				TIF < 40			
Radio interference			EN61000-6-3, EN61000-6-2. For others standards apply to factory							
Waveform Distors.(THD) at f. load	LL/LN %		1,6 / 1,8							
Waveform Distors.(THD) at no load	LL/LN %		2,9 / 3							
Mechanical characteristics										
Protection			IP 21 (other protection on request)							
DE bearing			6314.2RS							
NDE bearing			6311.2RS							
Weight of wound stator assembly	kg		97							
Weight of wound rotor assembly	kg		63							
Weight of complete generator	kg		331							
Maximun overspeed	rpm		2250							
Unbalanced magnetic pull at f.l.cl.F	kN/mm		4,9							
Cooling air requirement	m ³ /min		19,3				23			
Inertia Constant (H)	sec.		0,111				0,133			
Noise level at 1m/7m	dB(A)		79 / 65				83 / 69			

All technical data are to be considered as a reference and they can be modified without any notice.

This document is a propriety of Mecc Alte S.p.a..All rights reserved.

50 Hz

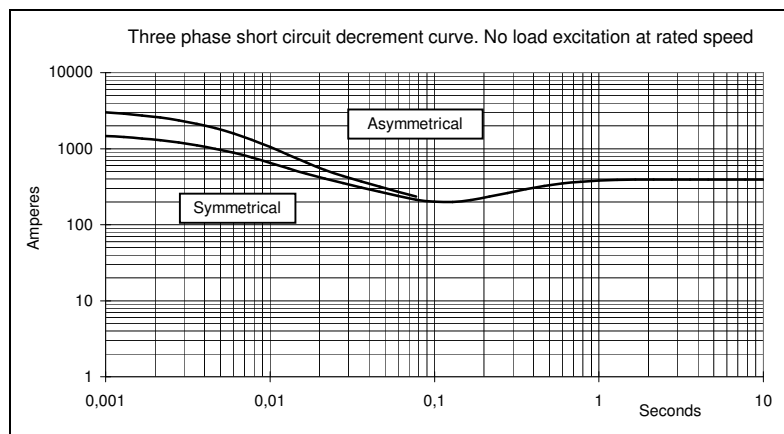
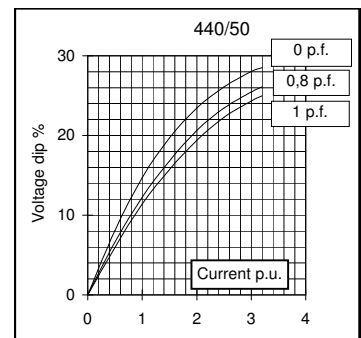
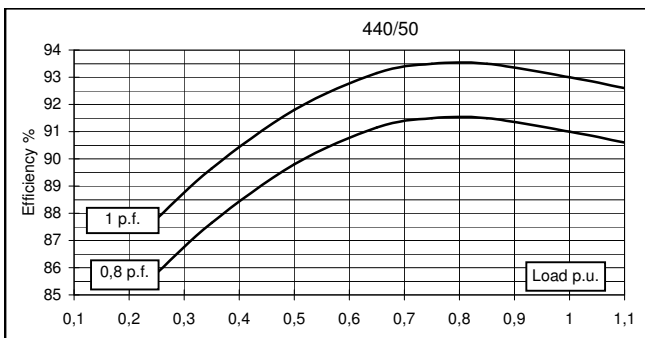
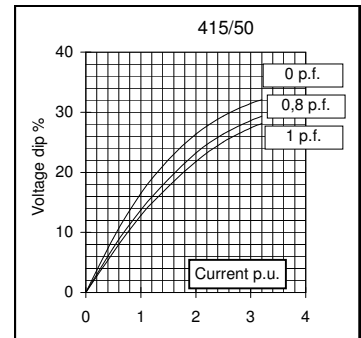
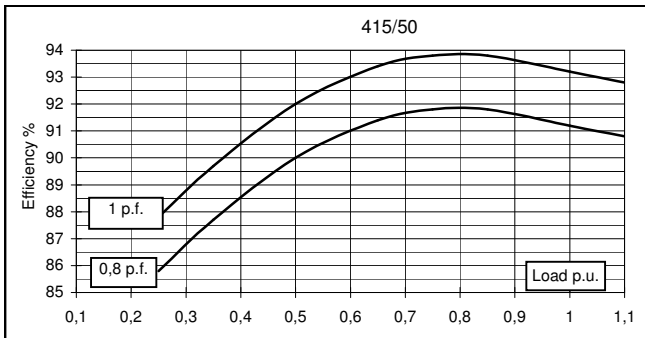
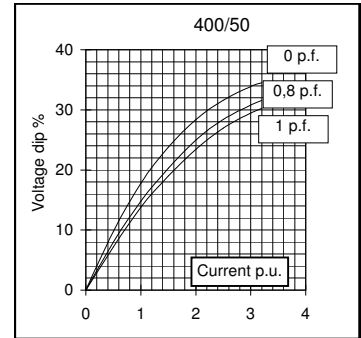
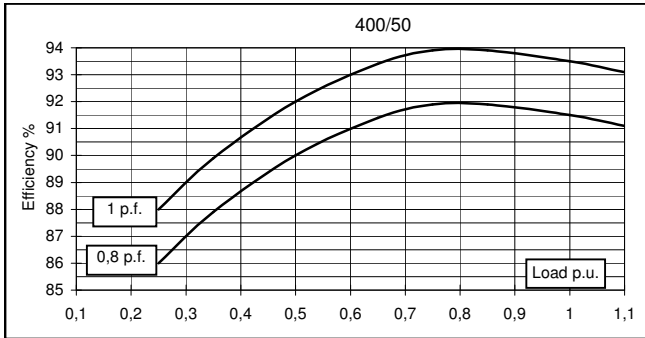
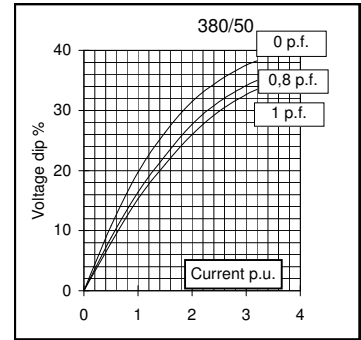
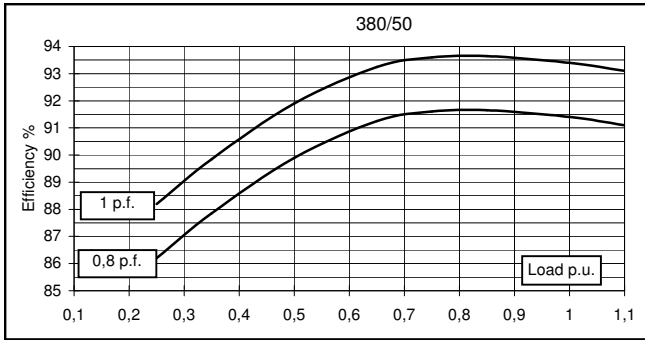

60 Hz

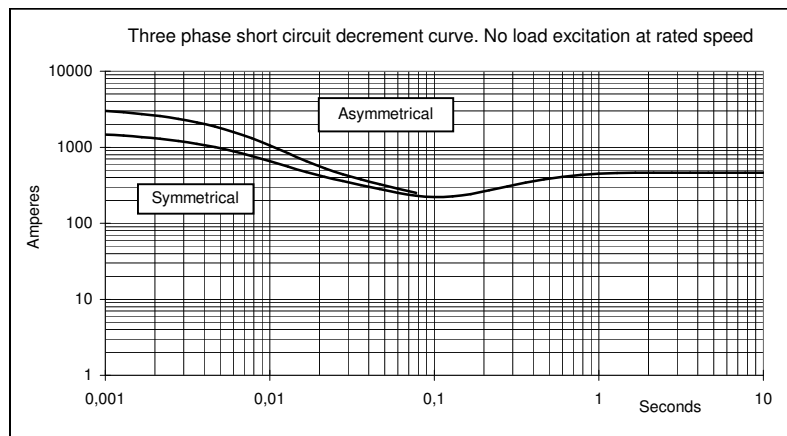
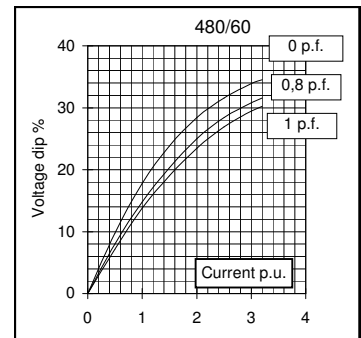
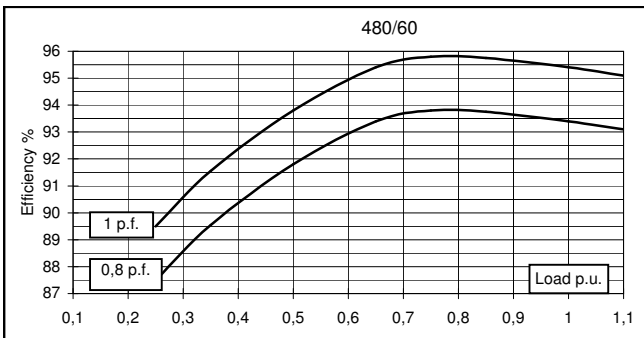
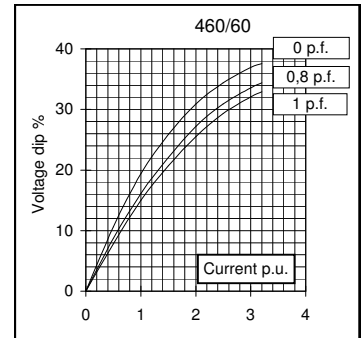
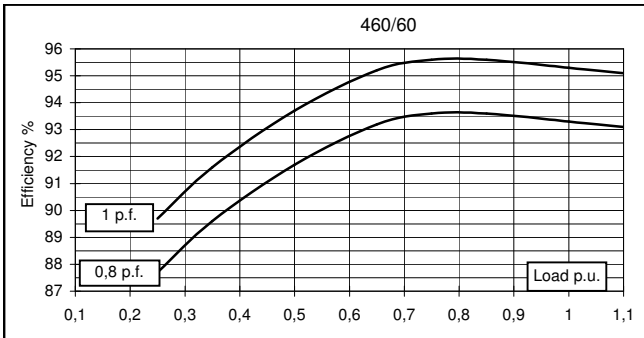
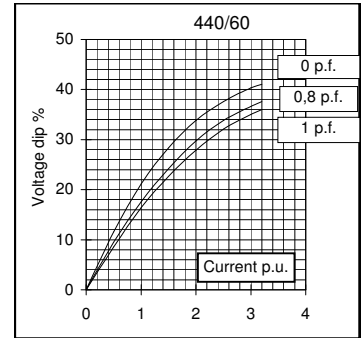
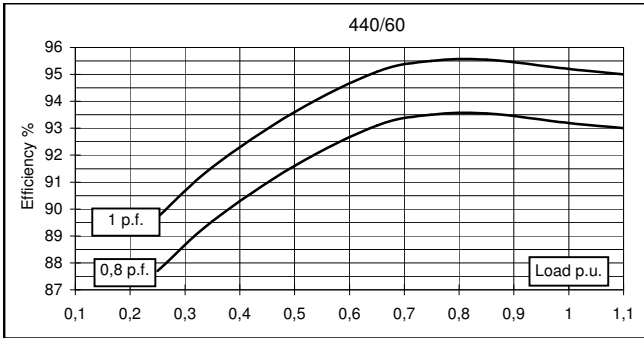
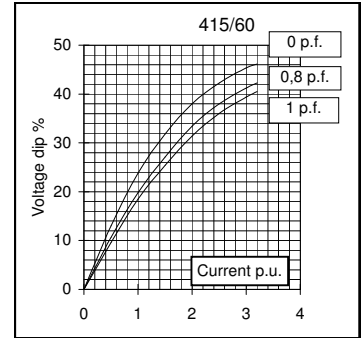
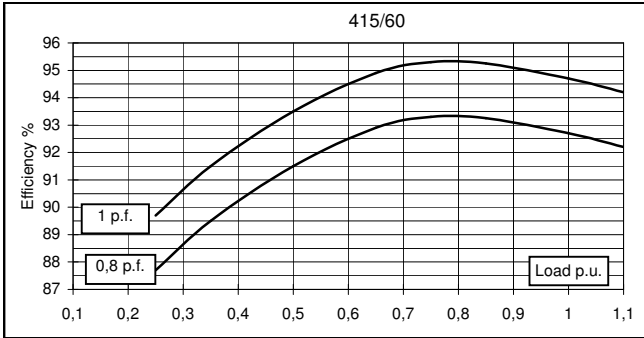

TWO BEARING MOMENTS OF INERTIA

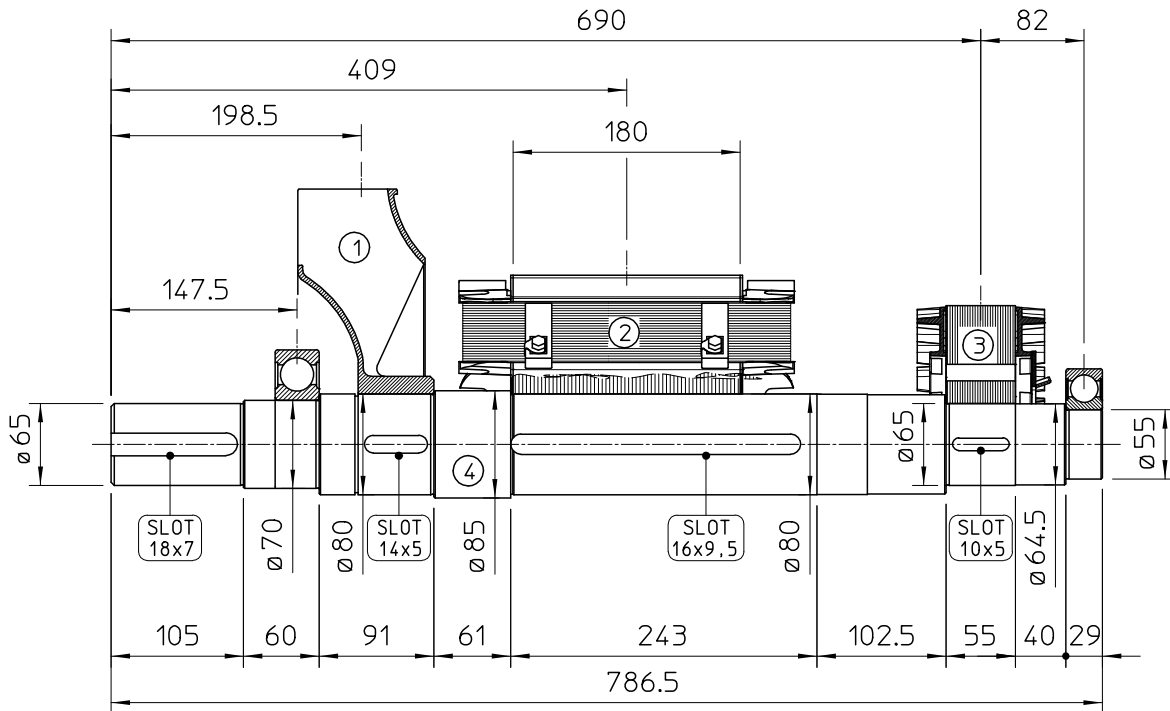

POS.	COMPONENT	WEIGHT (kg)	J (kgm ²)
1	FAN	3.6	0.0451
2	MAIN ROTOR	64.8	0.5847
3	EX. ROTOR	14.5	0.0874
4	SHAFT	26.8	0.0196
TOTAL		109.7	0.7368

TWO BEARING DIMENSIONS

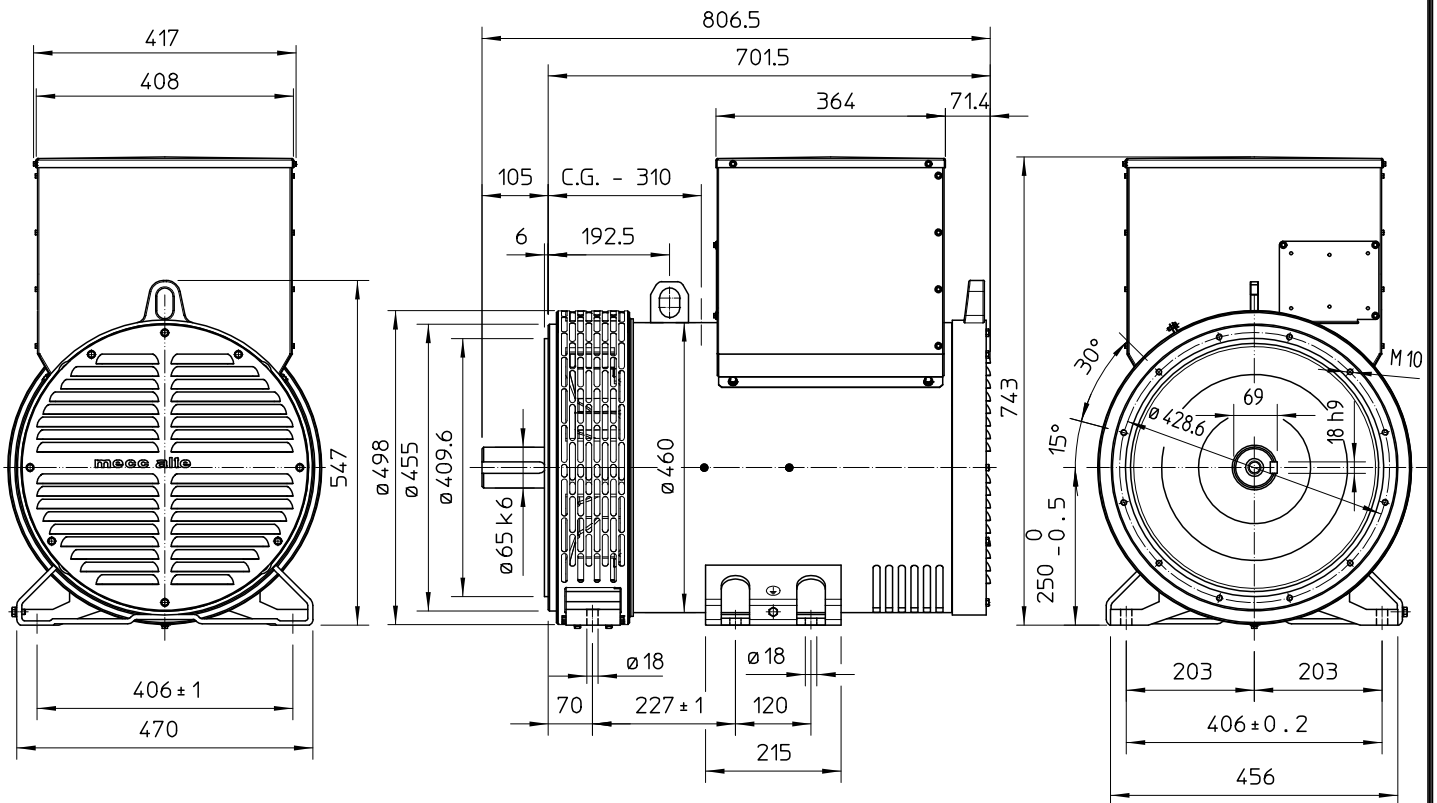

C.G.= GRAVITY CENTER

